

# MPR63-41 NETWORK ANALYSER



**ATTENTION : Consult the operating instructions before using the equipment.  
If these precautions are not properly observed and carried out, it can cause physical accident or damage to the equipment or the installation.  
The manufacturer or the authorized seller is not responsible for the consequences resulting from failure to comply with these precautions.**

We thank you for your smart choice. To obtain the best results from your equipment :

- carefully read the operating instructions ;
- observe the precautions mentioned here.

## SAFETY PRECAUTIONS

This equipment has been manufactured and tested and it has left the factory in perfectly safe condition. To preserve this and ensure safe operation of the equipment the user should comply with the instructions which are mentioned in this manual.



Before installing, check that the operating and network voltages are the same!

Before carrying out any work on the equipment, check that it is disconnected from the electrical supply.

If the equipment is no longer completely safe to use, it should be taken out of service and protected against any accidental use.

### Operator Safety

**Read the following recommendations carefully before installing and operating the equipment.**

The equipment described in this manual is designed only to be used by trained personnel.

Maintenance work must be carried out only by qualified, authorised personnel.

Personnel must observe the usual safety procedures for safe operation and during any maintenance work.

### Breakdown Precautions

If you suspect that the equipment may no longer be safe (e.g. because of transport or operational damage), it must be taken out of service and protected against any accidental use.

The equipment should be handed over to authorised technicians for checking.

### Cleaning Instructions

Disconnect the equipment from the electrical supply and only use a damp cloth to clean the external surfaces.

Do not use any abrasive materials or solvents. Do not allow any moisture to reach the connection terminals.

## Important note for system connection

① ② ③ indicators indicate the existence of the three phases. (See Figure 1)

If  $\Delta$  indicator (**Phase sequence is not correct**) is seen, you have to change any of the 2 phases before proceeding. (L1 - L2, L2 - L3 or L1 - L3)

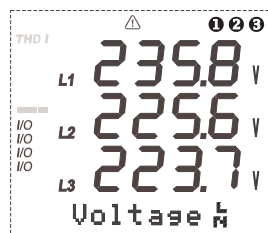

**Figure 1:** The existence of three phases on LCD.



## SUMMARY

<b>SAFETY PRECAUTIONS</b> .....	<b>1</b>
<b>IMPORTANT NOTE FOR SYSTEM CONNECTION</b> .....	<b>1</b>
<b>1. DESCRIPTION</b> .....	<b>3</b>
1.1 Introduction.....	3
1.2 The front panel.....	4
1.3 Front panel properties.....	5
1.4 The rear panel.....	6
<b>2. INSTALLATION</b> .....	<b>7</b>
2.1 Mechanical assembly.....	7
2.2 Operating conditions.....	7
2.3 Electrical connection.....	8
2.4 MPR63-41 PC Connection.....	9
<b>3. MODBUS RTU PROTOCOL</b> .....	<b>10</b>
3.1 Modbus functions.....	10
3.2 Features of connection cable.....	11
3.3 I/O Relay Status Register.....	11
3.4 Learning of device informations(2BH).....	11
3.5 Reading and writing to data logs from device (14H).....	11
3.6 File record information table.....	11
3.7 Energy log table.....	12
3.8 Error codes.....	13
3.9 MPR-SW (MPR63-41 Interface Program).....	13
3.10 Harmonic values for voltage values.....	13
3.11 Harmonic values for current values.....	13
3.12 Data register map (16 bit).....	14
3.13 Setup register map.....	15
3.14 Data register map (32 bit).....	16
<b>4. GENERAL MENU</b> .....	<b>17</b>
4.1 Setup.....	17
4.2 Network.....	18
4.3 Setting the date and time.....	18
4.4 PC Communication Settings (RS-485).....	18
4.5 Datalog.....	19
4.6 Output Relays and Digital Outputs (Relay 1 and Relay 2).....	20
4.7 Pulse Outputs (Pulse A and Pulse R).....	23
4.8 Display.....	25
4.9 Instantaneous Values.....	25
4.10 Energy.....	28
4.11 Harmonic.....	29
4.12 Demand.....	31
4.13 Observing the time and date.....	34
4.14 Info.....	34
4.15 Manufacturer-Product Information.....	35
4.16 Password.....	36
4.17 Parameter Table.....	37
4.18 Formulas.....	37
4.19 Analog Output (0/4-20mA).....	38
4.20 Factory Settings.....	39
4.21 Technical Data.....	40

# 1. DESCRIPTION

## 1.1 INTRODUCTION

MPR63-41 is a network analyser in 96x96 mm dimension with a non-flammable enclosure. It is designed for measuring all electrical parameters, including separately measured "current" and "voltage" harmonic values (up to 31th harmonic) of an electric network with MODBUS-RTU Protocol on RS-485 communication port in order to communicate with the computer.

Thanks to MPR-SW Software, the collected data are monitored in personal computer and saved in to its memory. MPR63-41 also has some other important features such as real time clock, **1 MB** internal memory, password for setup, alarm contact output, displaying minimum, maximum and demand values.



Figure 2: General view of the MPR63-41



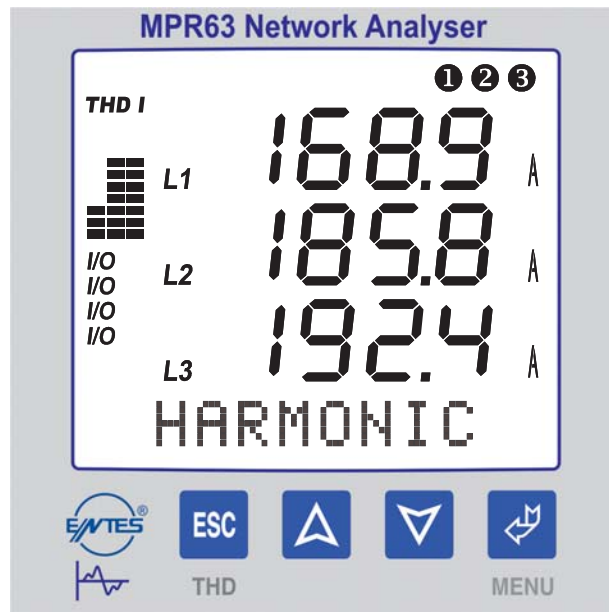

## 1.2 THE FRONT PANEL



**Figure 3:** Display and buttons.

4 (Four) buttons provide access to programming and measurement screens. The display is LCD and has a white backlight.

## KEY FUNCTIONS

BUTTON	FUNCTION
	Exit from a menu <b>any time</b> (THD I and THD V can also be displayed)
	Go to next menu or increase related value
	Go to the previous menu or decrease related value
	Enter to a menu or confirm the data entry

## 1.3 DISPLAY

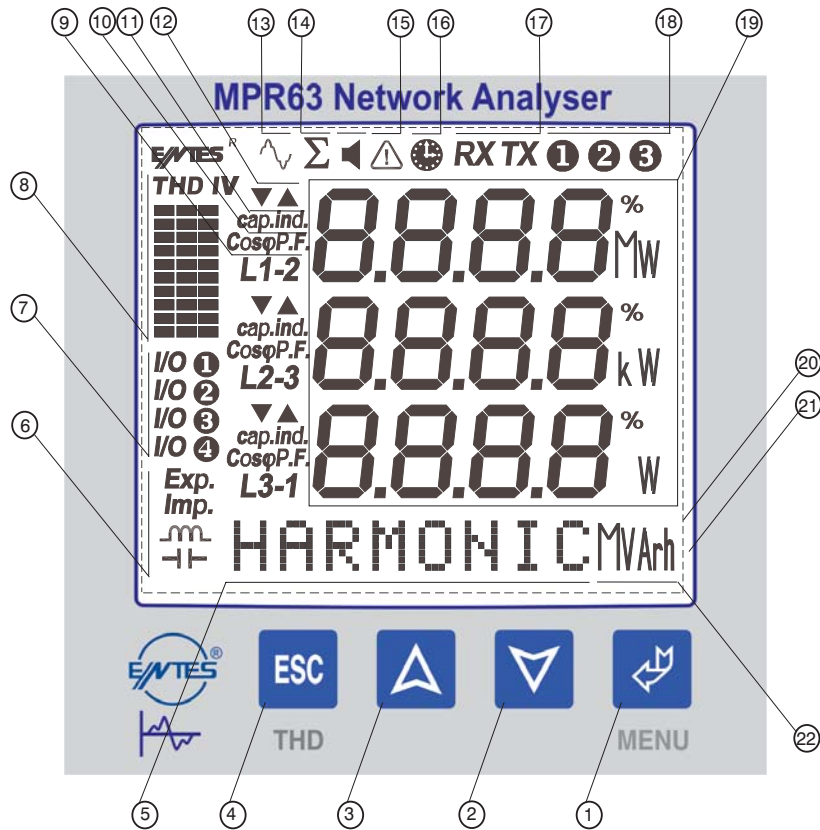

- 1 ..... Menu (ENTER) button.
- 2 ..... Down button.
- 3 ..... Up button.
- 4 ..... ESC button. Exits from a menu or settings at **any time**.  
(THD I, THD V can also be displayed)
- 5 ..... Menu / Energy line : Shows the present menu. / It also shows the energy values.
- 6 ..... Shows whether the value in the Energy Menu is Export, Import, Inductive or capacitive.
- 7 ..... Active output is indicated.
- 8 ..... Harmonic bars: The total harmonics of the 3 phases are displayed in bar graphs.  
The columns represent L1, L2 and L3 phases. Each step indicate 10% increase / decrease V is for the voltages harmonics and I is for the currents harmonics.
- 9 ..... Indicates if the measure is phase to phase or phase to neutral.
- 10..... The Cosφ or PF (Power Factor) value of the related phase.
- 11 ..... Indicates if the measurement is capacitive or inductive.
- 12 ..... Min. and Max. symbols for the demand menu.
- 13 ..... Indicates that the harmonics are displayed on the screen.
- 14 ..... Total symbol. Shows the total value of the related measurement.
- 15 ..... Phase sequence failure
- 16 ..... Demand symbol. Shows the demand value of the related parameter.
- 17 ..... PC Communication indicator.
- 18 ..... Phase indication symbols.
- 19 ..... Shows the following measurement values with units.  
(V, kV, MV, A, kA, MA, W, kW, MW, VA, kVA, MVA, VAr, kVAr, MVArh)
- 20 ..... 3.6" LCD Display.
- 21 ..... Backlight.
- 22 ..... Shows the unit of energy values. (kWh, kVArh)

## 1.4 THE REAR PANEL

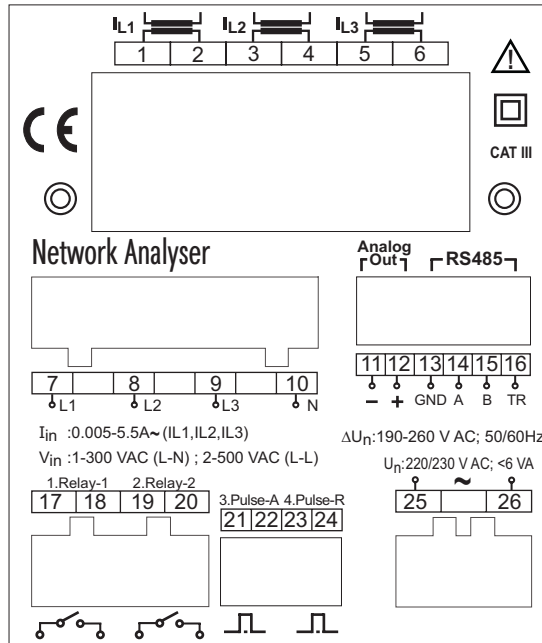

**Figure 4:** The terminals on the rear panel.

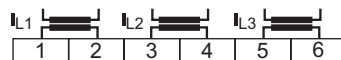

Current Monitoring Terminals

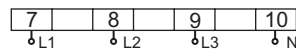

Voltage Monitoring Terminals

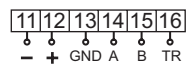

Analog Output / RS-485 Output

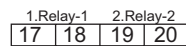

Alarm Outputs and Digital Outputs

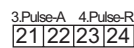

Energy Pulse Outputs



Auxiliary Supply Terminals

## 2. INSTALLATION

### 2.1 MECHANICAL ASSEMBLY

The following drawings are the overall dimensions for the device and the panel cut-out.

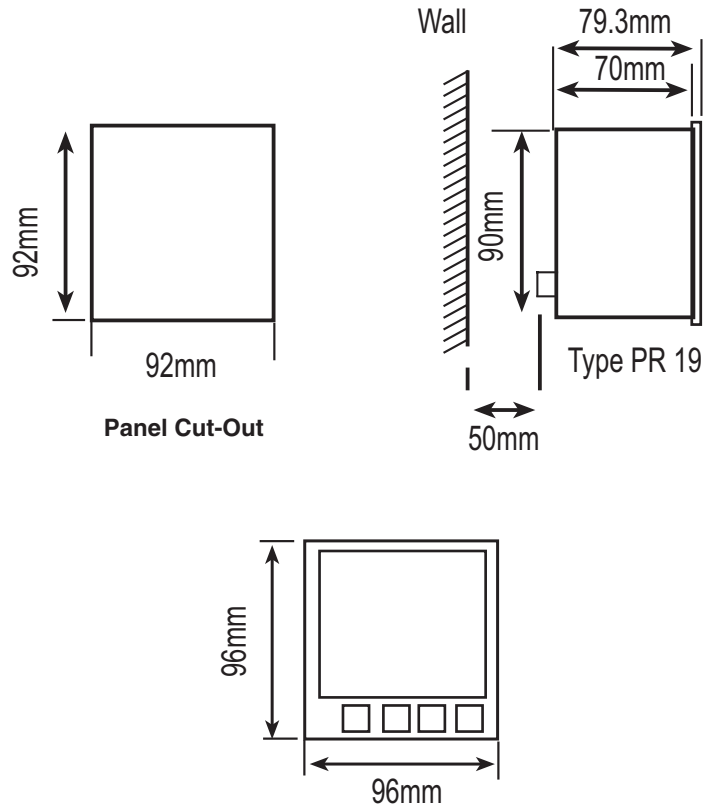

**Figure 5:** Dimension and the panel cut-out.

### 2.2 OPERATING CONDITIONS

#### CLIMATIC ENVIRONMENT

The device should be protected from water / dense moisture and be installed in a covered enclosure when used in a dusty environment. Ambient operating temperature is between  $-5^{\circ}\text{C}$  and  $+50^{\circ}\text{C}$

#### ELECTRICAL ENVIRONMENT

Although the device is protected against electrical current fluctuations, it is advisable to avoid the immediate proximity of equipment generating heavy drains (high power contactors, sets of busbars, etc.) The quality of communication obtained from the computer bus depends to a large extent on observing these precautions.

## 2.3 ELECTRICAL CONNECTION

Wire thickness for voltage terminals must be 2.5 mm<sup>2</sup> and 4.0 mm<sup>2</sup> for current terminals. For energy pulse outputs, the required wire thickness is 1.5 mm<sup>2</sup>. The fuse must be Type FF with 1A current limit.

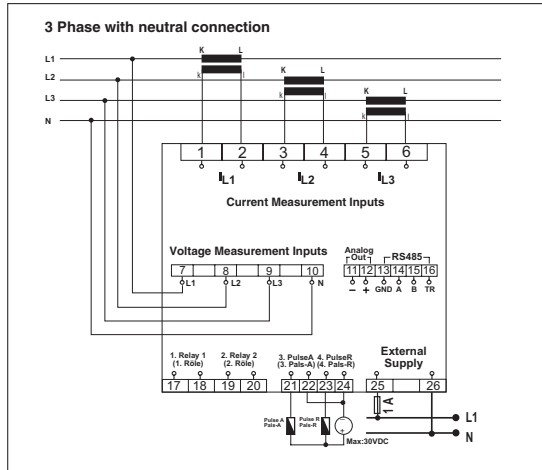

Figure 6: 3 phase with neutral connection

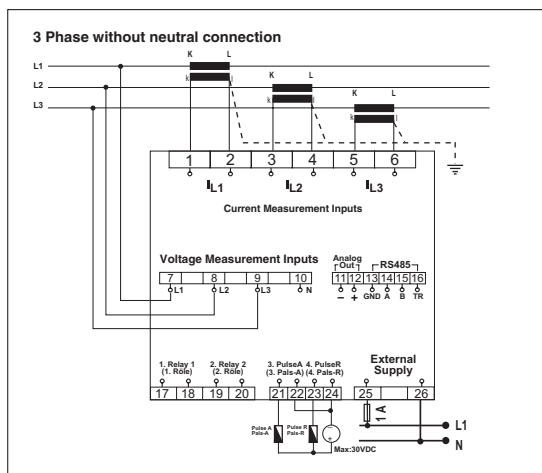

Figure 7: 3 phase without neutral connection

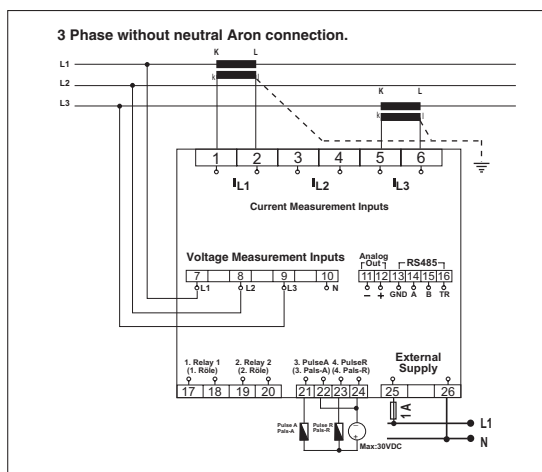
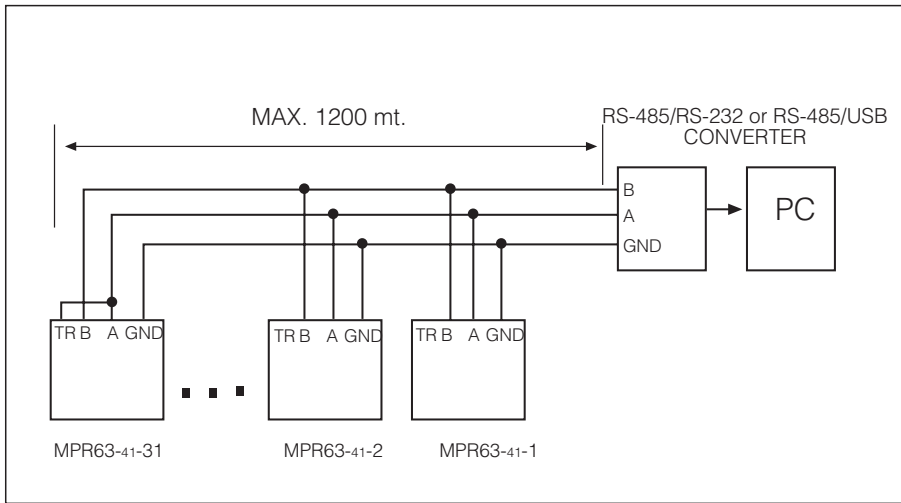

Figure 8: ARON connection (3 phase without neutral connection)



## 2.4 MPR63-41 PC CONNECTION

RS 485/232 Converter is necessary for communicating with computer.



**Figure 9:** 31 devices can be connected to the same line.

After 20 pieces of MPR63-41, a repeater is advised for amplifying the data signal.

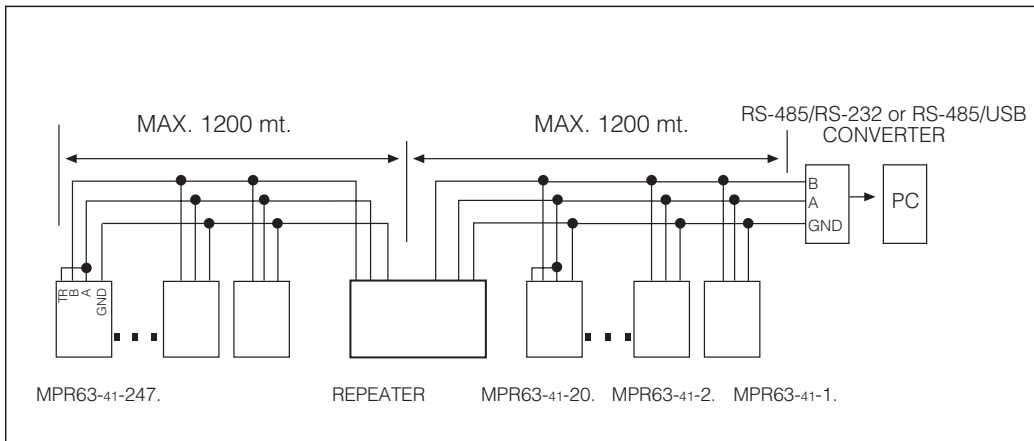

**Figure 10:** By using repeaters, 247 devices can be connected to the same line.

### 3. MODBUS RTU PROTOCOL

#### MODBUS RTU PROTOCOL

Standard message format of MODBUS RTU is as below :

T	ADDRESS 8 BITS	FUNCTION 8 BITS	DATA N x 8 BITS	CRCH	CRCL	T
---	-------------------	--------------------	--------------------	------	------	---

Starting and finishing of T times, which are as much as 3.5 characters time, are time periods of data lines which must be constant for evaluating by devices at the line if the message starts or finishes.

**Address** area, which is between 1 and 247, shows the serial address of device at the line.

**Data** area contains the data which is sent to device from slave to master or from master to slave.

**CRC** is a determination method of error which is used at the MODBUS RTU Protocol and it has 2 bytes

#### 3.1 Modbus Functions:

<b>03H</b>	REGISTER READING	<b>14H</b>	LOG DATA RECORD READING
<b>06H</b>	SINGLE REGISTER WRITING	<b>2BH</b>	DEVICE INFORMATION READING
<b>10H</b>	MULTIPLE REGISTER WRITING		

Register Reading (03H) function is used to read measured parameters and transformer ratios. If a register is tried to read except for values, device sends error message.

Example : This message must be sent to the device for reading the phase-neutral voltage of Phase 1;

**01** Device address  
**03** Function  
**00** MSB address  
**00** LSB address  
**00** Register numbers MSB  
**01** Register numbers LSB  
**84** CRC MSB  
**0A** CRC LSB

Single register writing command (06) is used to set the transformer ratios or clear any of min., max. or demand values. Current transformer ratio can be entered between 1 and 2000 and voltage transformer ratio can be entered between 1 and 4000. Only "0" (zero) value can be entered to the demand values.

For setting the CT ratio as 100;

**01** Device address  
**06** Function  
**01** MSB address  
**00** LSB address  
**00** Data MSB  
**64** Data LSB  
**89** CRC MSB  
**DD** CRC LSB

Multiple register writing command (10H) is used to change more than one register value. For setting the CT ratio as 100 and voltage transformer ratio as 2;

**01** Device address  
**10** Function  
**01** MSB address  
**00** LSB address  
**00** Register number MSB  
**02** Register number LSB  
**04** Byte number  
**00** Data MSB  
**64** Data LSB  
**00** Data MSB  
**C8** Data LSB  
**BE** CRC MSB  
**76** CRC LSB

#### RESPONSE

**01** Device address  
**10** Function  
**01** Register address (high)  
**00** Register address (low)  
**00** Number of registers (high)  
**02** Number of registers (low)  
**40** CRC (high)  
**34** CRC (low)

Parameters are transmitted as 16 bit hexadecimal.

For example:

- 230,6 V voltage value of the device is received as 2306 (0902H) and real value is obtained by multiplying to its multiplier (x0,1) and VT ratio
- 1,907A current value is received as 1907 (0773H) and it is multiplied by 0,001 and CT ratio
- -0,78 P.F. value is received as FCF4H. (16 bit signed integer)
- Energy values are sent as 2 words in 16 bit register table.

Energy value = (High x 10.000) + Low

Example :

**Low High**  
 06237819 kWh = 1E8BH 026FH



### 3.2 Features of connection cable:

- Screened
- 24 AWG or more thickness
- DC resistance : =<100 ohm/km
- Characteristic impedance : 100 ohm for 100kHz
- Capacitor between two conductors : =< 60 pF/m
- Capacitor between one conductor and earth : =< 120 pF/m

### 3.3 I/O Relay Status Register.

I/O Relay Status register is used to observe the status of MPR63-41's outputs

15	14	13	12	11	10	9	8	7	6	5	4	3	2	1	0
0	0	0	0	0	0	0	0	0	0	0	0	0	0	Relay2	Relay1

- When Relay 1 is switched on, 0 (zero) bit of I/O Relay Status Register is read as 1 and when Relay 1 is not switched on it is read as 0.
- When Relay 2 is switched on, 1st bit of I/O Relay Status Register is read as 1 and when Relay 2 is not switched on it is read as 0.
- If Relay Functions (Setup register:011AH/012DH) is set to "1" then Relay 1/2 functions as "Digital Output 1/2".

For switch **ON** Relay 1 **Example** : 01 06 00 4C 00 01 CRC  
 For switch **ON** Relay 2 **Example** : 01 06 00 4C 00 02 CRC  
 For switch **ON** both relays **Example** : 01 06 00 4C 00 03 CRC  
 For switch **OFF** both relays **Example** : 01 06 00 4C 00 00 CRC

### 3.4 Learning of device informations (2BH)

Following data packet is sent to device to learn the device code, program version, manufacturer name and manufacturer web site :

01 2B 0E 01 00 70 77

### 3.5 Reading and writing to data logs from device (14H)

Modbus RTU 14H function is used to transmit measured parameters to the computer, when the device is not connected with computer.

01 14 07 06 00 00 00 02 00 01 99 24

#### Answer

01 Device address  
 14 Function  
 07 Byte number  
 06 Referance type  
 00 File number MSB } 0-15  
 00 File number LSB }  
 00 Record number MSB } 0-999  
 02 Record number LSB }  
 00 Record length MSB } 1  
 01 Record length LSB }  
 99 CRC MSB  
 24 CRC LSB

01 Device address  
 14 Function  
 46 Data length  
 20 Record length  
 06 Referance type  
 00 Record number MSB  
 02 Record number LSB  
 02 Record date Day  
 10 Record date Month  
 05 Record date Year  
 19 Record date Hour  
 07 Record date Minute  
 23 Record date Second  
 08 Data 01 MSB  
 BC Data 01 LSB  
 08 Data 02 MSB  
 95 Data 02 LSB  
 : : : :  
 00 Data 28 MSB  
 00 Data 28 LSB  
 71 CRC MSB  
 B0 CRC LSB



**Warning** : Data logs must be deleted individually for each file.  
 For deleting the data logs at the File 0, below request must be sent.  
 Request : 01 06 04 01 00 00 D9 3A  
 Response : 01 06 04 01 00 00 D9 3A  
 record numbers

\* Please refer to page 12 for energy log table.

Log format	Type	Range
Index Hi	Word	0..999
Index Lo		
Day Hi	Word	1..31
Month Lo		
Year Hi	Word	00..99
Hour Lo		
Minute Hi	Word	00..59
Second Lo		
Data 01 Hi	Word	0..65535
Data 01 Lo		
Data 02 Hi	Word	0..65535
Data 02 Lo		
:		
Data 28 Hi	Word	0..65535
Data 28 Lo		

### 3.6 File Record Information Table

It shows the number of records, open file and total number of recordings of the files which have data logs.

ADDRESS	DESCRIPTION	DIMENSION
0400H	File which is recorded now. (0-15)	word
0401H	Record numbers at File 0	word
0402H	Record numbers at File 1	word
:	:	:
0410H	Record numbers at energy file	word
0411H	Total record numbers	word



### 3.7 Energy Log

Index	Energy Log Format	Dimension	Multiplier	Range	Unit
1	Index	Word	Data	0..999	-
2	Day(Hi)	Word	Data	1..31	d
	Month(Lo)			1..12	m
3	Year(Hi)	Word	Data	00..99	y
	Hour (Lo)			00..23	h
4	Minute(Hi)	Word	Data	00..59	m
	Second (Lo)			00..59	s
5	Import Active Energy(Lo)	Word	Data	-	kWh
6	Import Active Energy(Hi)	Word	Data x 10000	99999999	
7	Export Active Energy (Lo)	Word	Data	-	kWh
8	Export Active Energy(Hi)	Word	Data x 10000	99999999	
9	Inductive Reactive Energy(Lo)	Word	Data	-	kVArh
10	Inductive Reactive Energy(Hi)	Word	Data x 10000	99999999	
11	Capacitive Reactive Energy(Lo)	Word	Data	-	kVArh
12	Capacitive Reactive Energy(Hi)	Word	Data x 10000	99999999	
13	Voltage High LN1	Word	Data x VT x 0.1	0...Vmax	V
14	Voltage High LN2	Word	Data x VT x 0.1	0...Vmax	V
15	Voltage High LN3	Word	Data x VT x 0.1	0...Vmax	V
16	Current High L1	Word	Data x CT x 0.001	0...Imax	A
17	Current High L2	Word	Data x CT x 0.001	0...Imax	A
18	Current High L3	Word	Data x CT x 0.001	0...Imax	A
19	Current Demand L1	Word	Data x CT x 0.001	0...Imax	A
20	Current Demand L2	Word	Data x CT x 0.001	0...Imax	A
21	Current Demand L3	Word	Data x CT x 0.001	0...Imax	A
22	Total Curent High	Word	Data x CT x 0.001	0...Imax	A
23	Total Curent Low	Word	Data x CT x 0.001	0...Imax	A
24	Total Current Demand	Word	Data x CT x 0.001	0...Imax	A
25	Total Active Power Demand	Signed Word	Data x VT x CT	0..±Ptmax	W
26	Total Reactive Power Demand	Signed Word	Data x VT x CT	0..±Qtmax	VAr
27	Total Appearnt Power Demand	Word	Data x VT x CT	0..Stmax	VA
28	Frequency	Word	Data x 0.01	45.00..65.00	Hz
29	Total Power Factor	Signed Word	Data x 0.001	-1.000..1.000	-
30	Current Transformer Ratio	Word	Data	1..2000	-
31	Voltage Transformer Ratio	Word	Data x 0.1	1..4000.0	-
32	Energy Pack CRC	Word	Data	CRC 16	-

### 3.8 ERROR CODES

If an inappropriate message is sent to device in MODBUS-RTU protocol, device sends an error message.

Error codes are mentioned below :

#### 01 Invalid Function

This message is received when a function is used which is not supported by MPR63-41.

#### Example :

Request 01 07 04 01 00 00 CRC

Response **01** Device address

**87** 80 h + 07h

constant invalid function code

**01** Error code

**82** CRC (high)

**30** CRC (low)

#### 02 Invalid Register

This message is received when an address is wanted to reach which is not found in register table of MPR63-41.

#### Example :

Request 01 06 50 00 00 CRC

Response **01** Device address

**86** 80 h + 06h

constant function code

**02** Error code

**C3** CRC (high)

**A1** CRC (low)

#### 03 Invalid Data :

This message is received when data is not found in required value intervals which is wanted to write.

#### Example :

Request 01 03 00 00 00 FF CRC

Response **01** Device address

**83** 80 h + 03h

constant function code

**03** Error code

**01** CRC (high)

**31** CRC (low)

### 3.9 MPR-SW; MPR63-41 Interface Program

MPR-SW is a recording and analysis program which is designed to use with all Entes products which has RS-485 outputs. MPR-SW Program records each parameter of the connected Entes products with programmable time intervals, draws graphics, billing for the energy consumption between adjustable dates, with 2 way communication. Maximum 247 devices can communicate with one software.



MPR63-41 takes 64 samples in each period. For 50 Hz, it takes 3200 samples in one second and for 60 Hz, it takes 3840 samples in one second.



### 3.10 Harmonic Values for Voltages at the L1, L2 and L3 Phases

ADDRESS	DESCRIPTION	DIMENSION (16 bit)	MULTIPLIER	UNIT
0200H	.....	.....	.....	.....
0201H	.....	.....	.....	.....
0202H	V <sub>L1</sub> 2nd Harmonic	Word	Data x 0,1	%
0203H	V <sub>L1</sub> 3rd Harmonic	Word	Data x 0,1	%
⋮	⋮	⋮	⋮	⋮
021FH	V <sub>L1</sub> 31th Harmonic	Word	Data x 0,1	%
0220H	.....	.....	.....	.....
0221H	.....	.....	.....	.....
0222H	V <sub>L2</sub> 2nd Harmonic	Word	Data x 0,1	%
0223H	V <sub>L2</sub> 3rd Harmonic	Word	Data x 0,1	%
⋮	⋮	⋮	⋮	⋮
021FH	V <sub>L2</sub> 31th Harmonic	Word	Data x 0,1	%
0240H	.....	.....	.....	.....
0241H	.....	.....	.....	.....
0242H	V <sub>L3</sub> 2nd Harmonic	Word	Data x 0,1	%
0243H	V <sub>L3</sub> 3rd Harmonic	Word	Data x 0,1	%
⋮	⋮	⋮	⋮	⋮
025FH	V <sub>L3</sub> 31th Harmonic	Word	Data x 0,1	%

### 3.11 Harmonic Values for Currents at the L1, L2 and L3 Phases

ADDRESS	DESCRIPTION	DIMENSION (16 bit)	MULTIPLIER	UNIT
0300H	.....	.....	.....	.....
0301H	.....	.....	.....	.....
0302H	I <sub>L1</sub> 2nd Harmonic	Word	Data x 0,1	%
0303H	I <sub>L1</sub> 3rd Harmonic	Word	Data x 0,1	%
⋮	⋮	⋮	⋮	⋮
031FH	I <sub>L1</sub> 31th Harmonic	Word	Data x 0,1	%
0320H	.....	.....	.....	.....
0321H	.....	.....	.....	.....
0322H	I <sub>L2</sub> 2nd Harmonic	Word	Data x 0,1	%
0323H	I <sub>L2</sub> 3rd Harmonic	Word	Data x 0,1	%
⋮	⋮	⋮	⋮	⋮
031FH	I <sub>L2</sub> 31th Harmonic	Word	Data x 0,1	%
0340H	.....	.....	.....	.....
0341H	.....	.....	.....	.....
0342H	I <sub>L3</sub> 2nd Harmonic	Word	Data x 0,1	%
0343H	I <sub>L3</sub> 3rd Harmonic	Word	Data x 0,1	%
⋮	⋮	⋮	⋮	⋮
035FH	I <sub>L3</sub> 31th Harmonic	Word	Data x 0,1	%

### 3.12 Data Register Map (16 bit)

ADDRESS	DESCRIPTION	DIMENSION (16 bit)	MULTIPLIER	RANGE	UNIT
0000H	Voltage LN1	Word	Data x VT x 0.1	0 .. Vmax	V
0001H	Voltage LN2	Word	Data x VT x 0.1	0 .. Vmax	V
0002H	Voltage LN3	Word	Data x VT x 0.1	0 .. Vmax	V
0003H	Current LN1	Word	Data x CT x 0.001	0 .. Imax	A
0004H	Current LN2	Word	Data x CT x 0.001	0 .. Imax	A
0005H	Current LN3	Word	Data x CT x 0.001	0 .. Imax	A
0006H	Total Current	Word	Data x CT x 0.001	0 .. Imax	A
0007H	Active Power L1	Signed Int	Data x VT x CT	0 .. ±Pmax	W
0008H	Active Power L2	Signed Int	Data x VT x CT	0 .. ±Pmax	W
0009H	Active Power L3	Signed Int	Data x VT x CT	0 .. ±Pmax	W
000AH	Reactive Power L1	Signed Int	Data x VT x CT	0 .. ±Qmax	VAr
000BH	Reactive Power L2	Signed Int	Data x VT x CT	0 .. ±Qmax	VAr
000CH	Reactive Power L3	Signed Int	Data x VT x CT	0 .. ±Qmax	VAr
000DH	Apparent Power L1	Word	Data x VT x CT	0 .. Smax	VA
000EH	Apparent Power L2	Word	Data x VT x CT	0 .. Smax	VA
000FH	Apparent Power L3	Word	Data x VT x CT	0 .. Smax	VA
0010H	Power Factor L1	Signed Int	Data x 0.001	-1.000 .. 1.000	-
0011H	Power Factor L2	Signed Int	Data x 0.001	-1.000 .. 1.000	-
0012H	Power Factor L3	Signed Int	Data x 0.001	-1.000 .. 1.000	-
0013H	Cos L1	Signed Int	Data x 0.001	-1.000 .. 1.000	-
0014H	Cos L2	Signed Int	Data x 0.001	-1.000 .. 1.000	-
0015H	Cos L3	Signed Int	Data x 0.001	-1.000 .. 1.000	-
0016H	Voltage L12	Word	Data x VT x 0.1	0 .. Vmax	V
0017H	Voltage L23	Word	Data x VT x 0.1	0 .. Vmax	V
0018H	Voltage L31	Word	Data x VT x 0.1	0 .. Vmax	V
0019H	Voltage LN	Word	Data x VT x 0.1	0 .. Vmax	V
001AH	Voltage LL	Word	Data x VT x 0.1	0 .. Vmax	V
001BH	Frequency	Word	Data x 0.01	45.00 .. 65.00	Hz
001CH	Total Active Power	Signed Int	Data x VT x CT	0 .. ±Pt max	W
001DH	Total Reactive Power	Signed Int	Data x VT x CT	0 .. ±Qt max	VAr
001EH	Total Apparent Power	Word	Data x VT x CT	0 .. St max	VA
001FH	THD V1	Word	Data x 0.1	0 .. 999.9	%
0020H	THD V2	Word	Data x 0.1	0 .. 999.9	%
0021H	THD V3	Word	Data x 0.1	0 .. 999.9	%
0022H	THD V3P	Word	Data x 0.1	0 .. 999.9	%
0023H	THD I1	Word	Data x 0.1	0 .. 999.9	%
0024H	THD I2	Word	Data x 0.1	0 .. 999.9	%
0025H	THD I3	Word	Data x 0.1	0 .. 999.9	%
0026H	THD I3P	Word	Data x 0.1	0 .. 999.9	%
0027H	*Voltage High LN1	Word	Data x VT x 0.1	0 .. Vmax	V
0028H	*Voltage High LN2	Word	Data x VT x 0.1	0 .. Vmax	V
0029H	*Voltage High LN3	Word	Data x VT x 0.1	0 .. Vmax	V
002AH	*Voltage Low LN1	Word	Data x VT x 0.1	0 .. Vmax	V
002BH	*Voltage Low LN2	Word	Data x VT x 0.1	0 .. Vmax	V
002CH	*Voltage Low LN3	Word	Data x VT x 0.1	0 .. Vmax	V
002DH	*Current High L1	Word	Data x CT x 0.001	0 .. Imax	A
002EH	*Current High L2	Word	Data x CT x 0.001	0 .. Imax	A
002FH	*Current High L3	Word	Data x CT x 0.001	0 .. Imax	A
0030H	*Current Low L1	Word	Data x CT x 0.001	0 .. Imax	A
0031H	*Current Low L2	Word	Data x CT x 0.001	0 .. Imax	A
0032H	*Current Low L3	Word	Data x CT x 0.001	0 .. Imax	A
0033H	*Demand Current L1	Word	Data x CT x 0.001	0 .. Imax	A
0034H	*Demand Current L2	Word	Data x CT x 0.001	0 .. Imax	A
0035H	*Demand Current L3	Word	Data x CT x 0.001	0 .. Imax	A
0036H	*Total Current High	Word	Data x CT x 0.001	0 .. Imax	A
0037H	*Total Current Low	Word	Data x CT x 0.001	0 .. Imax	A
0038H	*Demand Total Current	Word	Data x CT x 0.001	0 .. Imax	A
0039H	*Demand Total Active Power	Signed Int	Data x VT x CT	0 .. ±Pt max	W
003AH	*Demand Total Reactive Power	Signed Int	Data x VT x CT	0 .. ±Qt max	VAr
003BH	*Demand Total Apparent Power	Word	Data x VT x CT	0 .. St max	VA
003CH	*Import Active Energy Lo	Word	(Data +)	-	-
003DH	*Import Active Energy Hi	Word	Data x 10000)	99999999	kWh
003EH	*Export Active Energy Lo	Word	(Data +)	-	-
003FH	*Export Active Energy Hi	Word	Data x 10000)	99999999	kWh
0040H	*Inductive Reactive Energy Lo	Word	(Data +)	-	-
0041H	*Inductive Reactive Energy Hi	Word	Data x 10000)	99999999	kVArh
0042H	*Capacitive Reactive Energy Lo	Word	(Data +)	-	-
0043H	*Capacitive Reactive Energy Hi	Word	Data x 10000)	99999999	kVArh
0044H	Hour	Word	Data	0 .. 23	h
0045H	Minute	Word	Data	0 .. 59	m
0046H	Second	Word	Data	0 .. 59	s
0047H	Day	Word	Data	0 .. 31	day
0048H	Month	Word	Data	0 .. 12	month
0049H	Year	Word	Data	00 .. 99	year
004AH	Current Transformer Ratio	Word	Data	1 .. 2000	-
004BH	Voltage Transformer Ratio	Word	Data x 0.1	1.0 .. 4000.0	-
004CH	IO Relay Status	Binary	Data & 0x0003	b0:Relay1,b1:Relay2	-
004DH	Total Power Factor	Signed Int	Data x 0.001	-1.000 .. 1.000	-
004EH	Neutral Current	Word	Data x CT x 0.001	0..IN max.	A

Word : 16bit Unsigned (0..65,535)  
Signed Int : 16bit Signed (-32,768 .. 32,767)

\* Writable registers (Only "0" (zero) value can be written)

### 3.13 Setup Register Map (16 bit)

ADDRESS	DESCRIPTION	DIMENSION (16bit)	MULTIPLIER	UNIT
0100H	Current Transformer Ratio	Word	Data	
0101H	Voltage Transformer Ratio	Word	Data x 0.1	
0102H	Net Type	Word	0:3P4W 1:3P3W 2:ARON	
0103H	Reserved	Word	Data	
0104H	Reserved	Word	Data	
0105H	Reserved	Word	Data	
0106H	Reserved	Word	Data	
0107H	Reserved	Word	Data	
0108H	Relay1 Parameter1	Word	Data	
0109H	Relay1 Hi1	Word	Data	
010AH	Relay1 Lo1	Word	Data	
010BH	Relay1 Delay1	Word	Data	sec.
010CH	Relay1 Hysteresis1	Word	Data	
010DH	Reserved	Word	Data	
010EH	Relay1 Parameter2	Word	Data	
010FH	Relay1 Hi2	Word	Data	
0110H	Relay1 Lo2	Word	Data	
0111H	Relay1 Delay2	Word	Data	sec.
0112H	Relay1 Hysteresis2	Word	Data	
0113H	Reserved	Word	Data	
0114H	Relay1 Parameter3	Word	Data	
0115H	Relay1 Hi3	Word	Data	
0116H	Relay1 Lo3	Word	Data	
0117H	Relay1 Delay3	Word	Data	sec.
0118H	Relay1 Hysteresis3	Word	Data	
0119H	Reserved	Word	Data	
011AH	Relay1 Function	Word	0:Alarm / 1:Digital Output	
011BH	Relay2 Parameter1	Word	Data	
011CH	Relay2 Hi1	Word	Data	
011DH	Relay2 Lo1	Word	Data	
011EH	Relay2 Delay1	Word	Data	sec.
011FH	Relay2 Hysteresis1	Word	Data	
0120H	Reserved	Word	Data	
0121H	Relay2 Parameter2	Word	Data	
0122H	Relay2 Hi2	Word	Data	
0123H	Relay2 Lo2	Word	Data	
0124H	Relay2 Delay2	Word	Data	sec.
0125H	Relay2 Hysteresis2	Word	Data	
0126H	Reserved	Word	Data	
0127H	Relay2 Parameter3	Word	Data	
0128H	Relay2 Hi3	Word	Data	
0129H	Relay2 Lo3	Word	Data	
012AH	Relay2 Delay3	Word	Data	sec.
012BH	Relay2 Hysteresis3	Word	Data	
012CH	Reserved	Word	Data	
012DH	Relay2 Function	Word	0:Alarm / 1:Digital Output	
012EH	A420_Parameter	Word	Data	
012FH	A420_Lo	Word	Data	
0130H	A420_Hi	Word	Data	
0131H	Log Period	Word	Data	sec.
0132H	Log Event	Word	0:Off / 1:On	
0133H	Log Energy Period	Word	Data	sec.
0134H	Log Par 1	Word	Data	
0135H	Log Par 2	Word	Data	
:	:	:	Data	
014FH	Log Par 28	Word	Data	
:	:	:	Data	
0156H	Demand Time	Word	Data	minute
0157H	Hour	Word	Data	h
0158H	Minute	Word	Data	m
0159H	Second	Word	Data	s
015AH	Day Of Week	Word	Data	day
015BH	Day	Word	Data	day
015CH	Month	Word	Data	month
015DH	Year	Word	Data	year
015EH	Reserved	Word	Data	
015FH	Reserved	Word	Data	
0160H	Total Energy / Separately	Word	0:Total/1:Separately	
0161H	Serial Number (1,2)	Word (Hi/Lo)	Char.1 / Char.2	ASC II
0162H	Serial Number (3,4)	Word (Hi/Lo)	Char.3 / Char.4	ASC II
0163H	Serial Number (5,6)	Word (Hi/Lo)	Char.5 / Char.6	ASC II
0164H	Serial Number (7,8)	Word (Hi/Lo)	Char.7 / Char.8	ASC II
0165H	Reserved	Word	Data	
0166H	Reserved	Word	Data	
0167H	Analog Output Type	Word	0: 4-20mA / 1: 0-20mA	

### 3.14 Data Register Map (32 bit)

(Following values are multiplied by Voltage and Current Transformer Ratios)

ADDRESS	DESCRIPTION	DIMENSION (32 bit)	MULTIPLIER	RANGE	UNIT
4000H	Voltage LN1	Long	Data x 0.01	0 .. Vmax x VT	V
4002H	Voltage LN2	Long	Data x 0.01	0 .. Vmax x VT	V
4004H	Voltage LN3	Long	Data x 0.01	0 .. Vmax x VT	V
4006H	Current LN1	Long	Data x 0.001	0 .. Imax x CT	A
4008H	Current LN2	Long	Data x 0.001	0 .. Imax x CT	A
400AH	Current LN3	Long	Data x 0.001	0 .. Imax x CT	A
400CH	Total Current	Long	Data x 0.001	0 .. Imax x CT	A
400EH	Active Power L1	Signed Long	Data x 0.01	0 .. ±Pmax x VT x CT	W
4010H	Active Power L2	Signed Long	Data x 0.01	0 .. ±Pmax x VT x CT	W
4012H	Active Power L3	Signed Long	Data x 0.01	0 .. ±Pmax x VT x CT	W
4014H	Reactive Power L1	Signed Long	Data x 0.01	0 .. ±Qmax x VT x CT	VAR
4016H	Reactive Power L2	Signed Long	Data x 0.01	0 .. ±Qmax x VT x CT	VAR
4018H	Reactive Power L3	Signed Long	Data x 0.01	0 .. ±Qmax x VT x CT	VAR
401AH	Apparent Power L1	Long	Data x 0.01	0 .. ±Smax x VT x CT	VA
401CH	Apparent Power L2	Long	Data x 0.01	0 .. ±Smax x VT x CT	VA
401EH	Apparent Power L3	Long	Data x 0.01	0 .. ±Smax x VT x CT	VA
4020H	Power Factor L1	Signed Long	Data x 0.001	-1.000 .. 1.000	-
4022H	Power Factor L2	Signed Long	Data x 0.001	-1.000 .. 1.000	-
4024H	Power Factor L3	Signed Long	Data x 0.001	-1.000 .. 1.000	-
4026H	Cos L1	Signed Long	Data x 0.001	-1.000 .. 1.000	-
4028H	Cos L2	Signed Long	Data x 0.001	-1.000 .. 1.000	-
402AH	Cos L3	Signed Long	Data x 0.001	-1.000 .. 1.000	-
402CH	Voltage L12	Long	Data x 0.01	0 .. Vmax x VT	V
402EH	Voltage L23	Long	Data x 0.01	0 .. Vmax x VT	V
4030H	Voltage L31	Long	Data x 0.01	0 .. Vmax x VT	V
4032H	Voltage LN	Long	Data x 0.01	0 .. Vmax x VT	V
4034H	Voltage LL	Long	Data x 0.01	0 .. Vmax x VT	V
4036H	Frequency	Long	Data x 0.01	45.00 .. 65.00	Hz
4038H	Total Active Power	Signed Long	Data x 0.01	0 .. ±Pt max x VT x CT	W
403AH	Total Reactive Power	Signed Long	Data x 0.01	0 .. ±Qt max x VT x CT	VAR
403CH	Total Apparent Power	Long	Data x 0.01	0 .. St max x VT x CT	VA
403EH	THD V1	Long	Data x 0.1	0 .. 999.9	%
4040H	THD V2	Long	Data x 0.1	0 .. 999.9	%
4042H	THD V3	Long	Data x 0.1	0 .. 999.9	%
4044H	THD V3P	Long	Data x 0.1	0 .. 999.9	%
4046H	THD I1	Long	Data x 0.1	0 .. 999.9	%
4048H	THD I2	Long	Data x 0.1	0 .. 999.9	%
404AH	THD I3	Long	Data x 0.1	0 .. 999.9	%
404CH	THD I3P	Long	Data x 0.1	0 .. 999.9	%
404EH	*Voltage High LN1	Long	Data x 0.01	0 .. Vmax x VT	V
4050H	*Voltage High LN2	Long	Data x 0.01	0 .. Vmax x VT	V
4052H	*Voltage High LN3	Long	Data x 0.01	0 .. Vmax x VT	V
4054H	*Voltage Low LN1	Long	Data x 0.01	0 .. Vmax x VT	V
4056H	*Voltage Low LN2	Long	Data x 0.01	0 .. Vmax x VT	V
4058H	*Voltage Low LN3	Long	Data x 0.01	0 .. Vmax x VT	V
405AH	*Current High L1	Long	Data x 0.001	0 .. Imax x CT	A
405CH	*Current High L2	Long	Data x 0.001	0 .. Imax x CT	A
405EH	*Current High L3	Long	Data x 0.001	0 .. Imax x CT	A
4060H	*Current Low L1	Long	Data x 0.001	0 .. Imax x CT	A
4062H	*Current Low L2	Long	Data x 0.001	0 .. Imax x CT	A
4064H	*Current Low L3	Long	Data x 0.001	0 .. Imax x CT	A
4066H	*Demand Current L1	Long	Data x 0.001	0 .. Imax x CT	A
4068H	*Demand Current L2	Long	Data x 0.001	0 .. Imax x CT	A
406AH	*Demand Current L3	Long	Data x 0.001	0 .. Imax x CT	A
406CH	*Total Current High	Long	Data x 0.001	0 .. Imax x CT	A
406EH	*Total Current Low	Long	Data x 0.001	0 .. Imax x CT	A
4070H	*Demand Total Current	Long	Data x 0.001	0 .. Imax x CT	A
4072H	*Demand Total Active Power	Signed Long	Data x 0.01	0 .. ±Pt max x VT x CT	W
4074H	*Demand Total Reactive Power	Signed Long	Data x 0.01	0 .. ±Qt max x VT x CT	VAR
4076H	*Demand Total Apparent Power	Long	Data x 0.01	0 .. St max x VT x CT	VA
4078H	*Import Active Energy	Long	Data	99999999	kWh
407AH	*Export Active Energy	Long	Data	99999999	kWh
407CH	*Inductive Reactive Energy	Long	Data	99999999	kVArh
407EH	*Capacitive Reactive Energy	Long	Data	99999999	kVArh
4080H	Hour	Long	Data	0 .. 23	h
4082H	Minute	Long	Data	0 .. 59	m
4084H	Second	Long	Data	0 .. 59	s
4086H	Day	Long	Data	0 .. 31	day
4088H	Month	Long	Data	0 .. 12	month
408AH	Year	Long	Data	00 .. 99	year
408CH	Current Transformer Ratio	Long	Data	1 .. 2000	-
408EH	Voltage Transformer Ratio	Long	Data x 0.1	1.0 .. 4000.0	-
4090H	IO Relay Status	Binary	Data & 0x0003	b0:Relay1,b1:Relay2	-
4092H	Total Power Factor	Signed Long	Data x 0.001	-1.000 .. 1.000	-
4094H	Neutral Current	Long	Data x 0.001	0..IN max.	A

Long : 32bit Unsigned (Hi:Lo) 0..4294967295  
Signed Long : 32bit Signed (Hi:Lo) -2,147,483,648 .. 2,147,483,647  
\* Writable registers (Only "0" (zero) value can be written)





**Warning :**

You may quit all settings **any time** by **ESC** key.  
You must record any change in the settings by  menu key.

## 4. GENERAL MENU

### 4.1 SETUP

In order for correct measurements and applications, make necessary configurations in the SETUP menu.  
Sub-menus under the SETUP menu and settings are explained in detail below.

### 4.2 Network

In this menu, current transformer primary value, voltage transformer ratio and system connection type of MPR63-41 are set.

It has 4 sub-menus. “CT:.....”, “VT:.....”, “Net:.....”, “Eng:.....”

#### CT (Current Transformer Ratio)

The current transformer **ratio** is set between 1...2000.

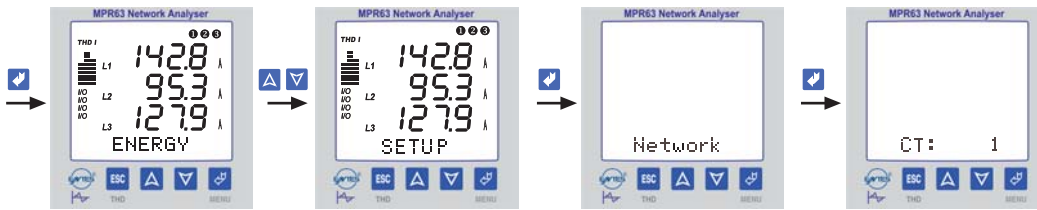

Figure 11: Setting the current transformer ratio

#### VT (Voltage Transformer Ratio)

The voltage transformer ratio can be adjusted between 1.0...4000.0

Please be careful that this value must be the voltage transformer ratio but not the value of the primary or secondary voltage.

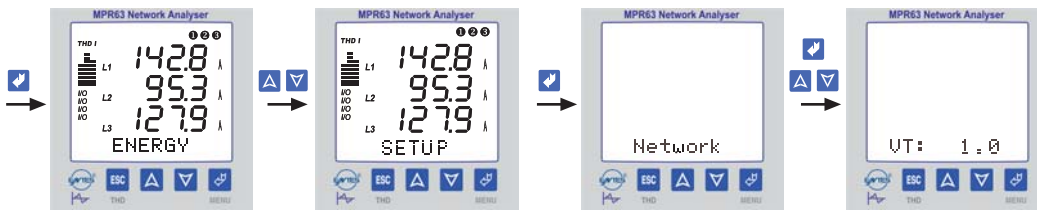

Figure 12: Setting the voltage transformer ratio

#### Net (Network Type)

The network type is set in this menu.

- 3P4W** : 3 Phase + Neutral (Star connection)
- 3P3W** : 3 Phase without Neutral (Delta connection)
- ARON** : ARON connection.

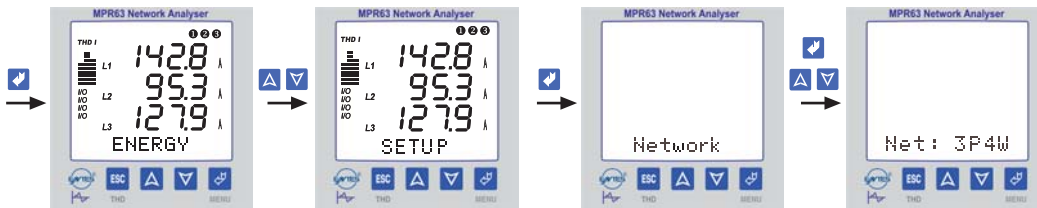

Figure 13: Setting the type of system connection

#### Eng

If “Tot” menu is selected, MPR63-41 measures the reactive powers of the phases. If the total reactive power of the phases is inductive, it is recorded to the inductive area; If capacitive, it is recorded to the reactive area. If “Sprt” menu is selected, MPR63-41 measures the reactive powers of three phases for each phase separately. If it is in the inductive area, it is recorded to the inductive reactive area. If it is in the capacitive area, it is recorded to the capacitive reactive area.

Measurement for each phase separately can be done for 3P4W (3 Phase with Neutral) systems.

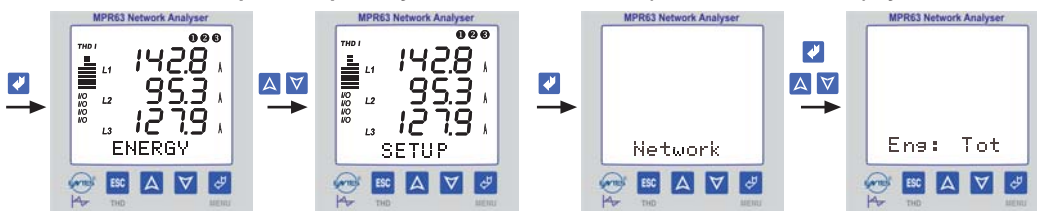

Figure 14: Setting the energy calculation type



**Warning :**

You may quit all settings **any time** by **ESC** key.  
You must record any change in the settings by  menu key.

### 4.3 Date and Time

It is essential to set the correct date and the time to obtain the right dates on the datalog menu  
**Date (DD/MM/YYYY)**

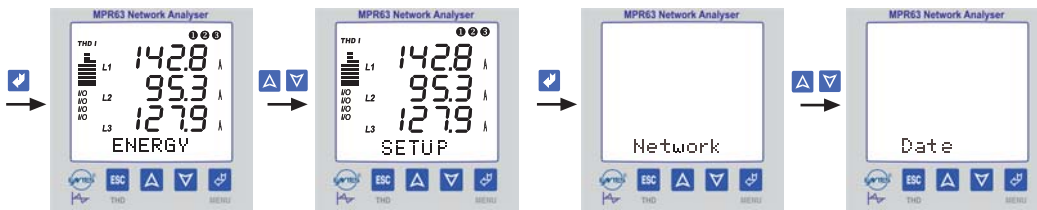

Figure 15: Setting the date

#### Time (Hour / Minute / Seconds)

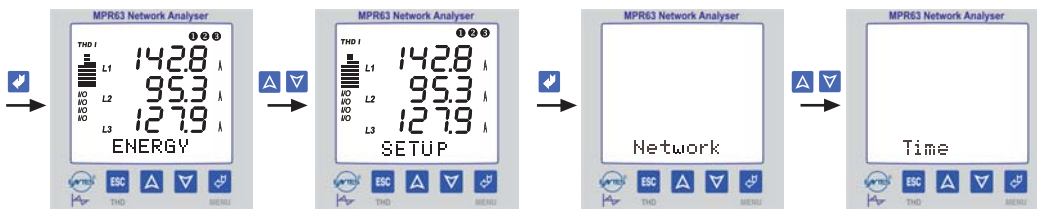

Figure 16: Setting the time

### 4.4 RS-485 (PC Communication Settings)

All the measured parameters can be transferred to PC through the MPR-SW Software by MODBUS RTU Protocol.  
MPR63-41 can be configured with PC through the MPR-SW Software.

**It is necessary to set the Baud Rate, Address and Parity values to the MPR63-41 device correctly.**

RS-485 has 3 sub-menus “Addr: ...”, “Bd: ...”, “Prt: ...”

#### Addr (Address Information)

Address Information can be set between 1 and 247.

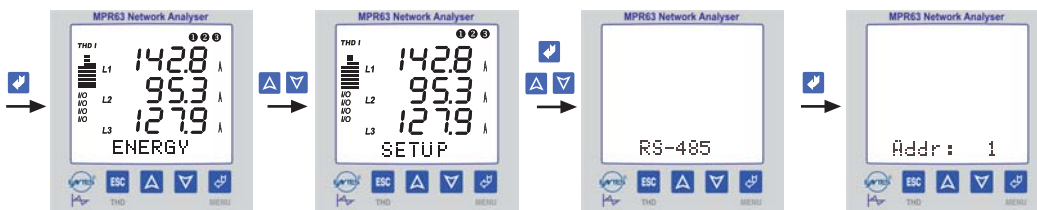

Figure 17: Setting the address information

#### Bd (Baud Rate Value)

Baud rate is set between 1200 bps and 38400 bps.

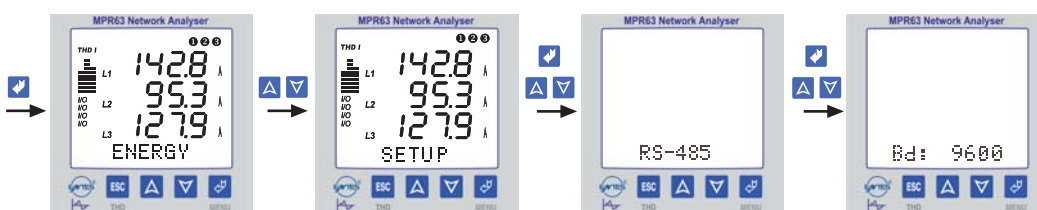



Figure 18: Setting the baud rate value



**Warning :**

You may quit all settings **any time** by **ESC** key.  
You must record any change in the settings by  menu key.

### Prt (Parity Settings)

Parity settings are set as none, even or odd.

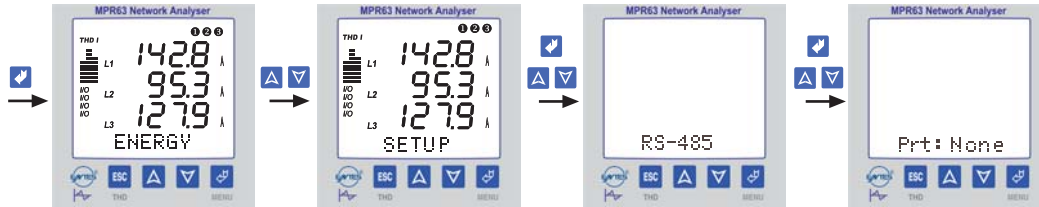

**Figure 19:** Setting the Parity Settings



**IMPORTANT NOTE:**

The "PARITY" should be selected as **None** in order to communicate with MPR-SW Software.

## 4.5 Datalog

MPR63-41 records the chosen 28 parameters in its **1 MB memory** with date and time stamp. The choice of the parameters and recording details are set in Datalog menu. These records can be monitored on the PC and not affected by energy cut off.

The "Datalog" menu has 30 sub-menus.

"Pr1:..." "Pr2:..." ..... "Pr28:..." , "Per:..." , "Event:..."

### "Pr1: ..." "Pr2: ..." ..... "Pr28:..." (Parameter Menus)

28 parameters can be associated with these sub menus with one parameter per each menu which will be recorded to memory

**The list of available parameters are marked with an asterisk (\*) on the parameter table (See page 35).**

15.000 record lines can be stored in memory on the condition, where the total 28 parameters are called as one record line.

At 15.001st record, the first 1000 records are cleared automatically. And then, last record will be read as 14001th.

**Note:**



Even if less than 28 parameters are entered in sub menus, MPR63-41's memory allocation is still for 28 parameters for each record line. So assigning less parameters do not increase memory capacity.

### Parameter Settings

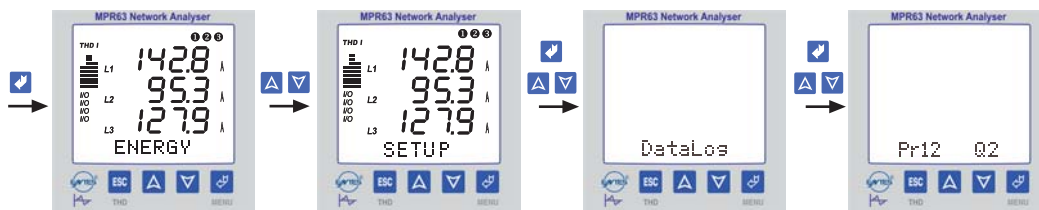
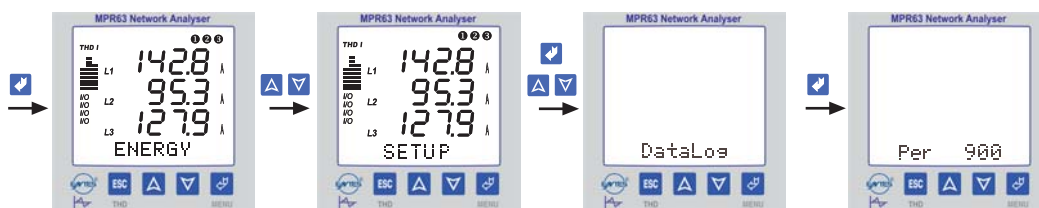

**Figure 20:** Setting the "Pr12" Parameter

### Per (Period Menu)

Period is the time interval between 2 consecutive records and can be set between 5 - 32.000 seconds.

**If period is set to "off", then no parameters will be recorded.**



**Figure 21:** Setting the period time



**Warning :**

You may quit all settings **any time** by **ESC** key.  
You must record any change in the settings by  menu key.

**Event**

When “event” is on, the associated parameter array is recorded in case any of the output relays are switched on / off, regardless of period. So, the parameter values can be examined at the time of relay switching on.

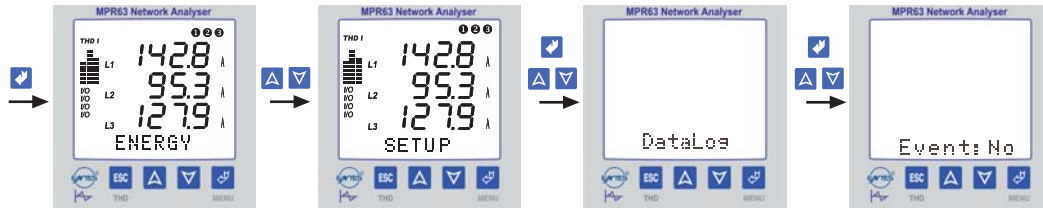

Figure 22: Setting the event

### 4.6 1. Relay 1 and 2. Relay 2

MPR63-41 has 2 relays (NO Normally open) for alarm outputs.

Any 3 parameters can be associated with any of the two relays at the same time. For each parameter, under, over, hysteresis and time delay values can be programmed. If the measured value of the set parameter exceeds the programmed values during the delay time, output relay switches on.

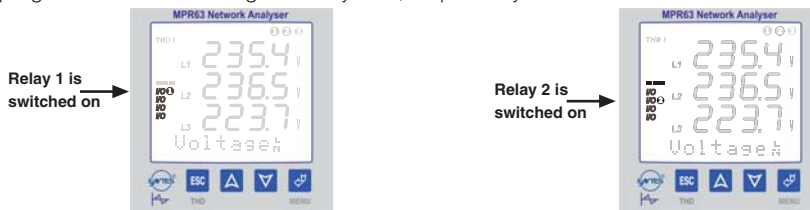

Figure 23: Active relays are displayed on LCD.

#### 1. Relay 1 / (2. Relay 2)

The list of the parameters which can be associated with relays are marked with \* on parameter table on page 37.

Relay 1 / (Relay 2) has 16 sub-menus.

**Cfg:** Configuration

**Pr :** Parameter

**Hi :** High (over)

**Lo :** Low (under)

**Hs :** Hysteresis

**Dly:** Time Delay

Menu of 1st Parameter

“Pr1:...”, “Hi1:...”, “Lo1:...”, “Hs1:...”, “Dly1:...”

Menu of 2nd Parameter

“Pr2:...”, “Hi2:...”, “Lo2:...”, “Hs2:...”, “Dly2:...”

Menu of 3rd Parameter

“Pr3:...”, “Hi3:...”, “Lo3:...”, “Hs3:...”, “Dly3:...”

#### Cfg (Configuration)

By this parameter, relays can be configured as “Alarm Output” (Cfg: Alarm) or as “Remote Control” (Cfg: DOut).

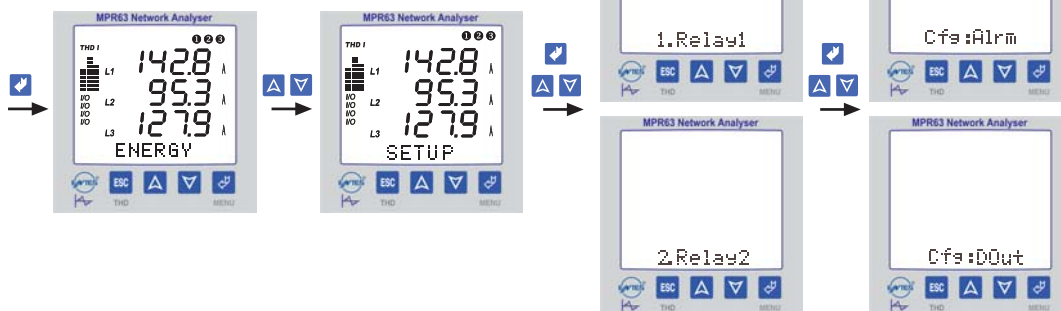
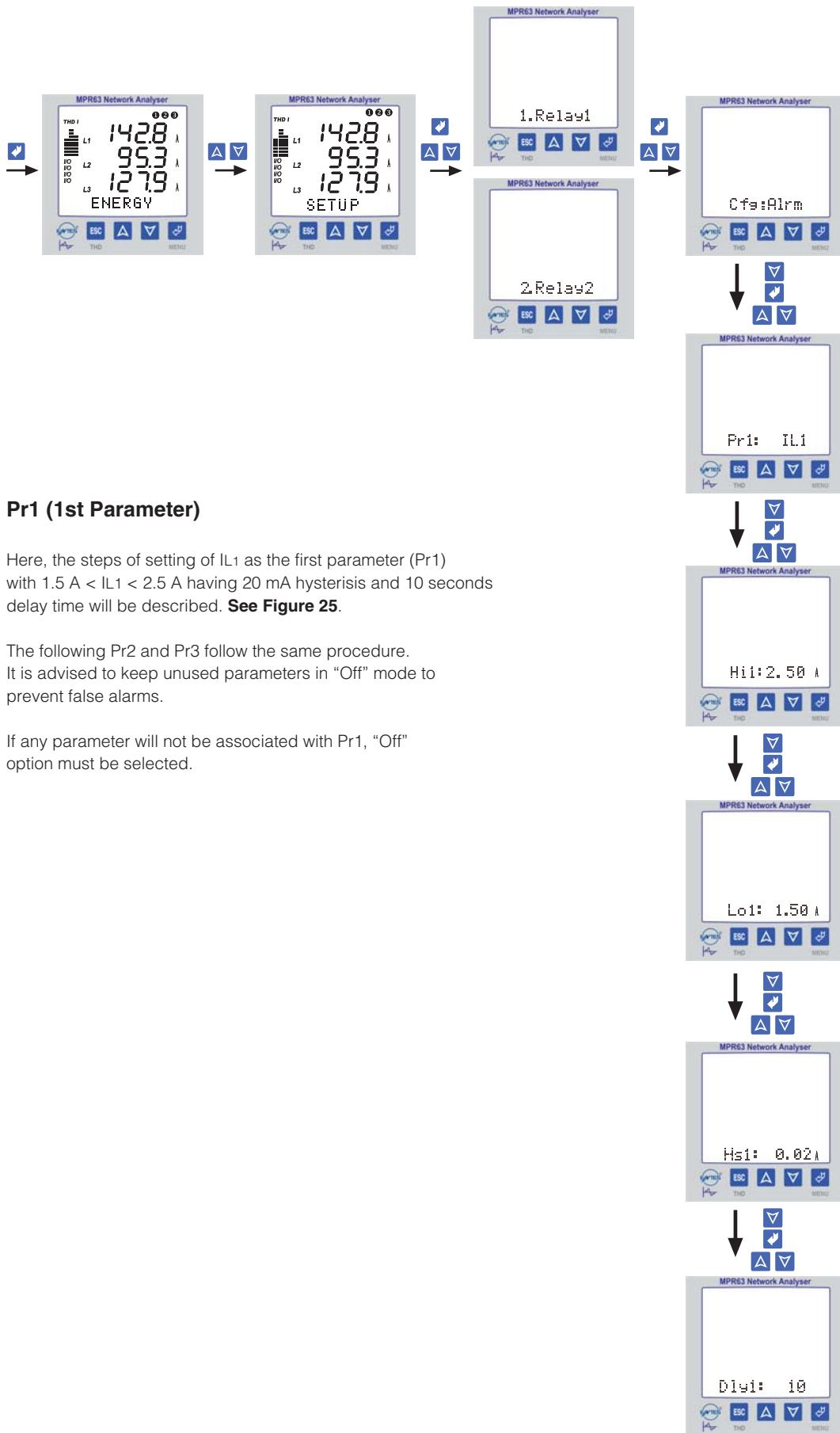

Figure 24: Relay control type setting



### Pr1 (1st Parameter)

Here, the steps of setting of IL1 as the first parameter (Pr1) with  $1.5 \text{ A} < IL1 < 2.5 \text{ A}$  having 20 mA hysteresis and 10 seconds delay time will be described. **See Figure 25.**

The following Pr2 and Pr3 follow the same procedure. It is advised to keep unused parameters in “Off” mode to prevent false alarms.

If any parameter will not be associated with Pr1, “Off” option must be selected.

**Figure 25:** Setting of IL1 as the first parameter with  $1.5 \text{ A} < IL1 < 2.5 \text{ A}$  having 20 mA hysteresis and 10 seconds delay time.



**Warning :**

You may quit all settings **any time** by **ESC** key.  
You must record any change in the settings by  menu key.

### Hi1 (High / over value for the 1st parameter)

When the measured value is over the Hi1 value, Relay 1 (or Relay 2) is switched on complying with Hs1 (Hysterisis 1) and Dly1 (Delay 1) values.

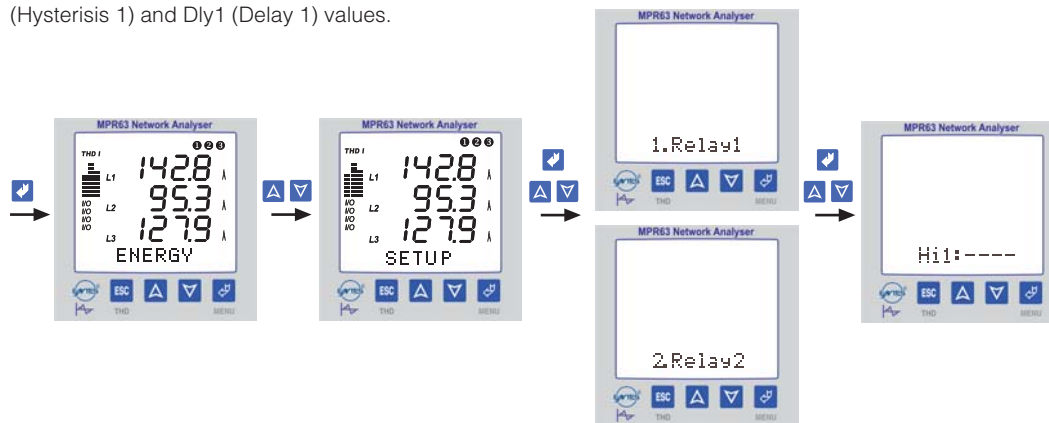

**Figure 26:** Setting the high (over) value for the 1st parameter

### Lo1 (Low / under value for the 1st parameter)

When the measured value is under the Lo1 value, Relay 1 (or Relay 2) is switched on complying with Hs1 (Hysterisis 1) and Dly1 (Delay 1) values.

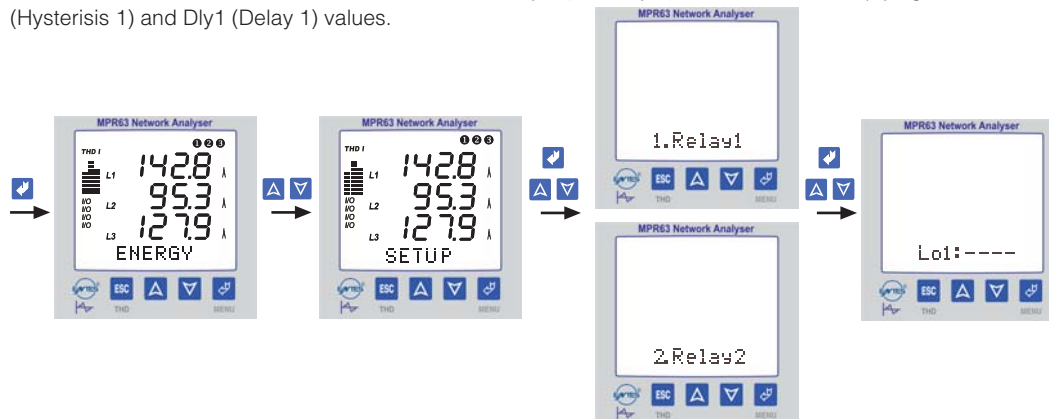
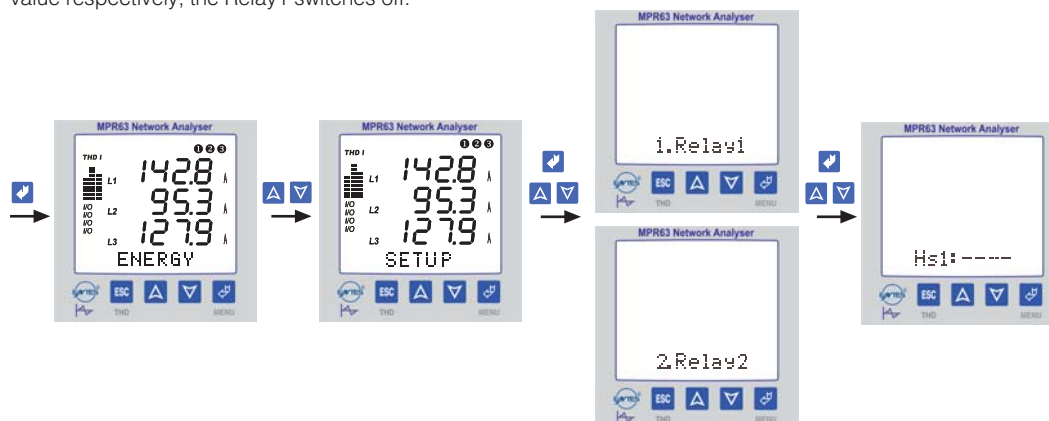

**Figure 27:** Setting the low (under) value for the 1st parameter

### Hs1 (Hysterisis value for the 1st parameter)

This function is added to prevent system from unexpected oscillations during switch off.

When the switch off values of the associated parameters are over (or under) of Lo1 (or Hi1) values as the hysteresis value respectively, the Relay1 switches off.



**Figure 28:** Setting the hysteresis value for the 1st parameter



**Warning :**

You may quit all settings **any time** by **ESC** key.  
You must record any change in the settings by menu key.

**Dly1 (Delay time for the 1st parameter)**

When the triggering signal is sent to the relay1, the relay1 will wait during the delay time before switching on.  
If the alarm signal is over during the delay time, the relay1 will not switch on.

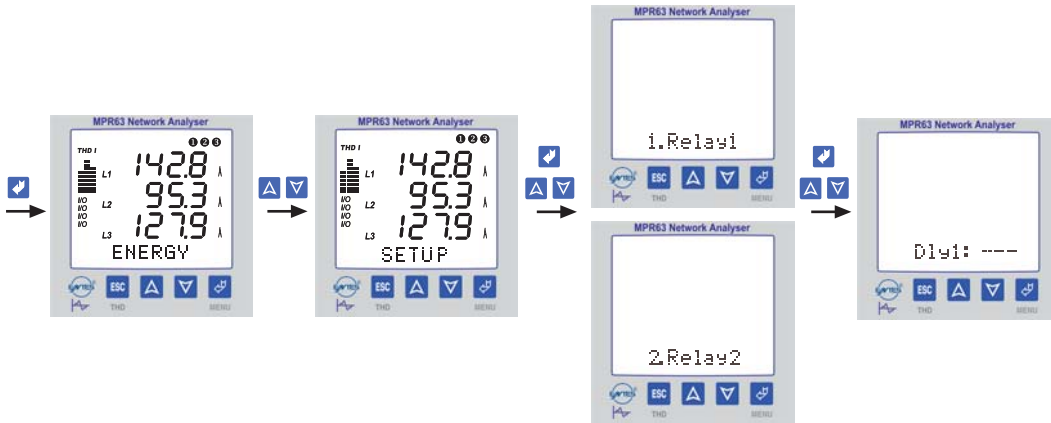
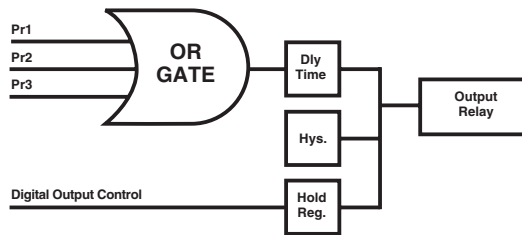

**Figure 29:** Setting the delay time for the 1st parameter.



**Warning**

Where more than one parameter is associated with the output relay, and when the output relay is triggered by more than one measure, switch-off will be realized by the last remaining measure.



**4.7 3. Pulse A / 4. Pulse R**

**Pulse Outputs (For Energymeters)**

MPR63-41 has 2 Pulse Outputs. (isolated NPN transistor) It is possible to see, which one of these outputs generate pulse, from the LCD at any time.

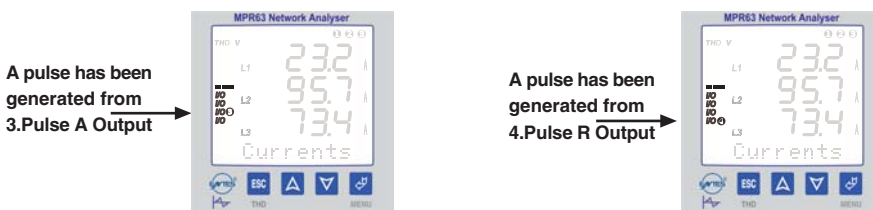

Each time the consumed energy increases by an increment of "Prm", a pulse, as long as the "Dur" value entered (msec), is produced in the Pulse Outputs.

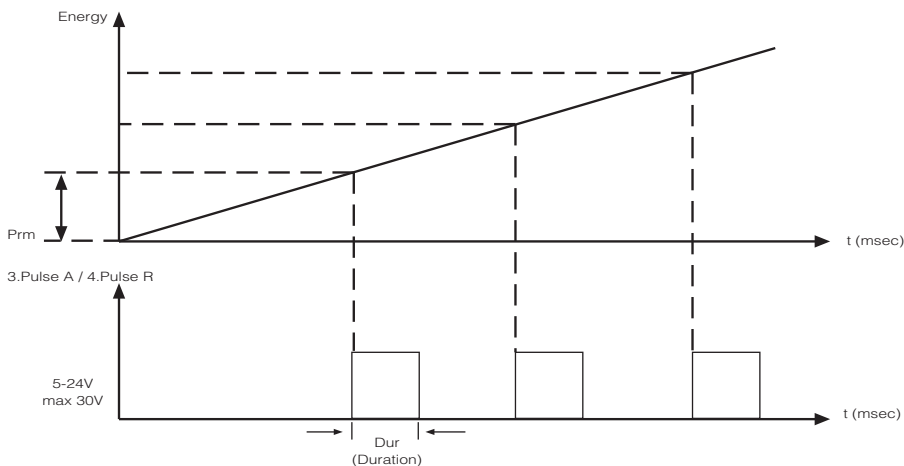

**Figure 30:** Energy - Pulse output graphic



**Warning :**

You may quit all settings **any time** by **ESC** key.  
You must record any change in the settings by  menu key.

**3. Pulse A (Import Active Energy Pulse Output) /**

**4. Pulse R (Inductive Reactive Energy Pulse Output)**

A pulse is generated in 3. Pulse A relevant with the import active energy value or in 4. Pulse R relevant with the inductive reactive energy value. For example, a pulse for every increase of 10 kWh for 3. Pulse A or for every increase of 10 kVARh for 4. Pulse R.

3. Pulse A (4. Pulse R) has 2 sub-menus. “Prm: ...”, “Dur: ...”

**Prm (Import Active / Inductive Reactive Energy Value to Set for 1 Pulse)**

A pulse is generated from 3. Pulse A output for each increase of the Prm value by a desired amount (1 kWh...50.0 MWh)

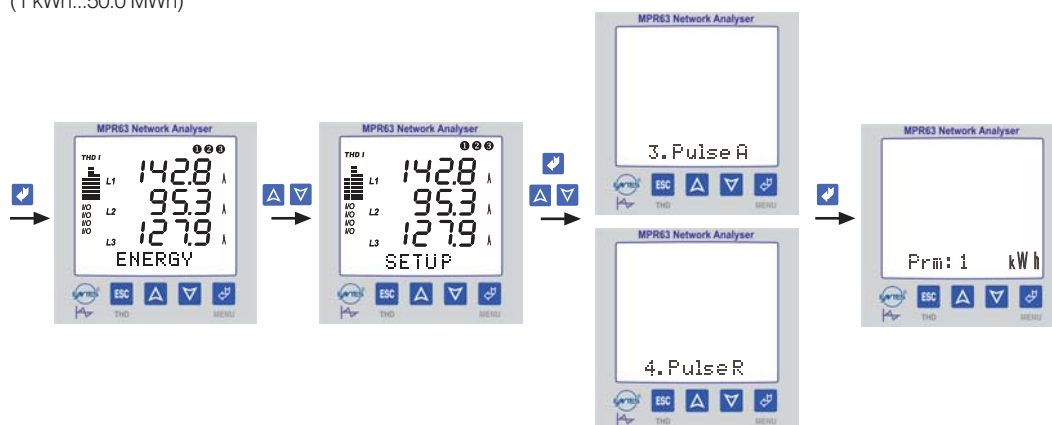

Figure 31: Setting the parameter value

**Dur (Pulse Width in Milliseconds)**

The pulse width is adjusted between 100 - 2500 msec.

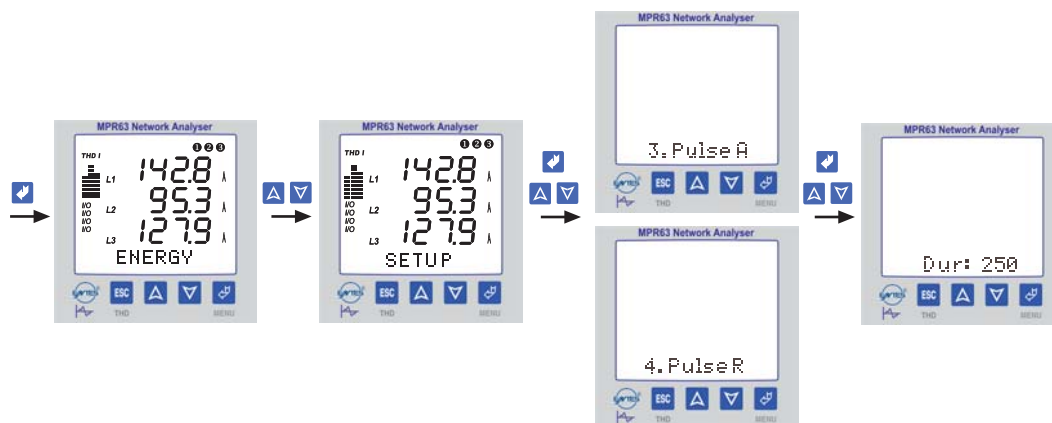

Figure 32: Setting the pulse width.

**See page 28 for energy measurement.**



**Note :** Even though the sub-menus under the 3. Pulse A and 4. Pulse R have the same names, these menus are independent of each other.

**For Example:**

It is possible to enter a specific parameter to the sub-menu “Prm” of 3. Pulse A and a different parameter to the sub-menu “Prm” of 4. Pulse R.





**Warning :**

You may quit all settings **any time** by **ESC** key.  
You must record any change in the settings by  menu key.

## 4.8 Display

In this menu, LCD display settings are configured. It has 3 sub-menus. “Loop: ...”, “Cont: ...”, “BL: ...”

### Loop (Loop duration)

In this menu, the duration of displaying instantaneous value is adjusted automatically. The Loop duration can be adjusted as “No” or between 1... 600 in terms of seconds.

**For example;** when the loop duration is set as 10sec. in the Instantaneous Values menu, if any button is not pressed during 10 sec. the Instantaneous values are displayed in sequence for 10 seconds periods.

By using this function all instantaneous values can be observed sequentially without pressing any buttons.

This function can be cancelled by selecting “No” option in the Loop Menu.

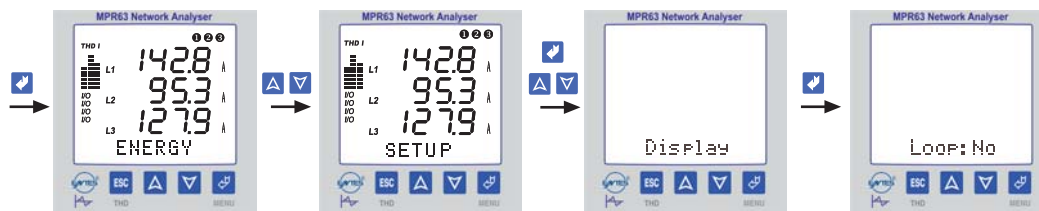

Figure 33: Setting the loop duration

### Cont (Contrast - LCD Display Clarity Settings)

The value can be set between 1...6.

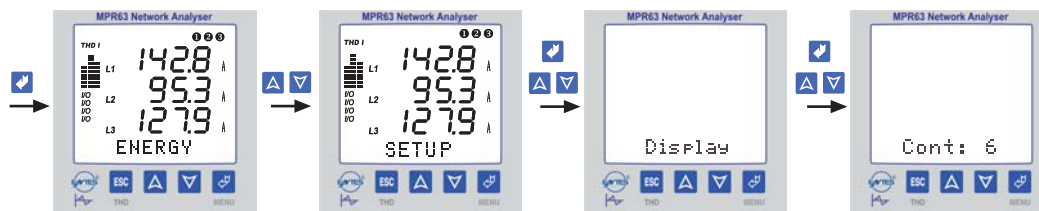

Figure 34: Setting the contrast clarity

### BL (Backlight)

Measured values can easily be read on the LCD screen even in dark environments with feature of the backlight function.

**On** : Backlight is On continuously.

**Off** : Backlight is Off continuously.

**Auto** : Backlight is switched on automatically when a button is pressed. It is switched off automatically at the end of 30 seconds if any button is not pressed again.

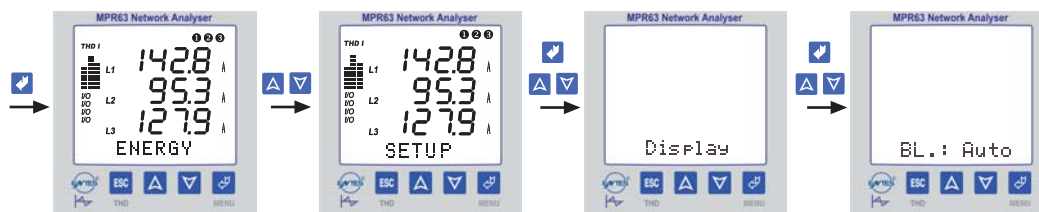

Figure 35: Setting the contrast clarity

## 4.9 INSTANTANEOUS VALUES

This menu is the last menu that is reached by pressing ESC button while in any menu.

Also it is the main menu of MPR63-41. If you wait a while without pressing any buttons in any menu, the Instantaneous value menu automatically comes back.

When MPR63-41 is energized for the first time, the device is in the Instantaneous values menu and shows the instantaneous values.

The display is seen as below.



At the bottom of the screen, the active sub-menu is displayed. Each bar on the left indicates the ratio between total harmonic amount of current or voltage for each phase as a percentage value. Each step is 10%. It is possible to switch between "THD V" and "THD I" by ESC button. Also, it is possible to see the numerical values of the THD values by going to the Instantaneous Values Menu.

THD V : Total Harmonic Distortion of Voltage  
 THD I : Total Harmonic Distortion of Current

By scrolling with **▲** (UP), **▼** (DOWN) buttons while in the Instantaneous Values Menu, the below parameters of the network are displayed.

Voltage <sub>n</sub>	-	Voltage <sub>t</sub>	-	Currents	-	P. Factor	-	Cosφ	-	Active (W)
Reactive (VAR)	-	Apparent (VA)	-	ΣPowers	-	Σ P.F.	-	THD V %	-	THD I %
Freq. Hz	-	Average <sub>n</sub>	-	Average <sub>t</sub>	-	ΣCurrent	(Neutral Current)			

**Voltage<sub>n</sub>** Measured phase-neutral voltage value VL1, VL2, VL3

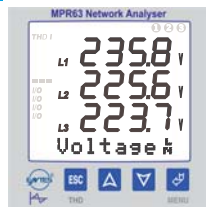

**Voltage<sub>t</sub>** Measured phase-phase voltage value VL1-2, VL2-3, VL3-1

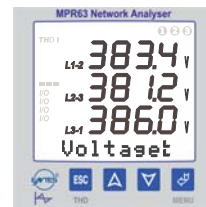

**Currents** Current measure of each phase IL1, IL2, IL3

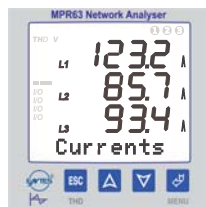

**P. Factor** Power factor measure of all phases PF L1, PF L2, PF L3

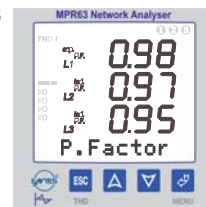

**Cosφ** Cosφ measure of all phases Cosφ L1, Cosφ L2, Cosφ L3

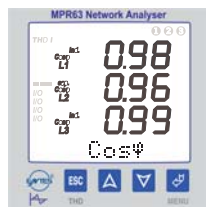

**Active** Active power measure of all phases P L1, P L2, P L3

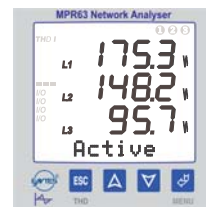

**Reactive** Reactive power measure of all phases Q L1, Q L2, Q L3

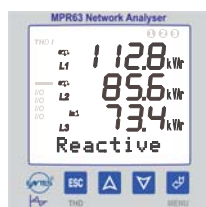

**Apparent** Apparent power measure of all phases S L1, S L2, S L3

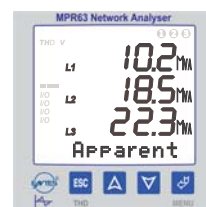

**$\Sigma$ Powers** Measured total active, total reactive and total apparent power values  
 $\Sigma P, \Sigma Q, \Sigma S$

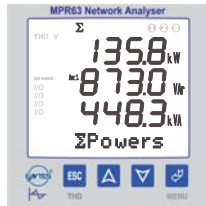

**$\Sigma P.F.$**  Total power factor values of all phases

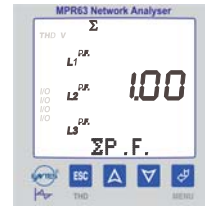

**THD V%** The total harmonic values for voltages of each phase

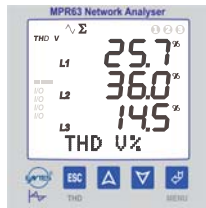

**THD I%** The total harmonic values for currents of each phase

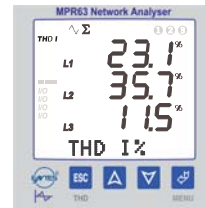

**NOTES:**

- \* If there is "-" symbol before the measured active power, it indicates the existence of active export power.
- \* When ARON connection is chose, "L2 - - -" symbol is seen at the **Currents, P.Factor, Cos $\phi$ , Active, Reactive, Apparent, THD I%, Har. I, DEMAND, max.I.L, DEMAND min.I.L, DEMAND I.L** menus.
- \* The total current-voltage harmonic values are displayed in THD V% and THD I% menus as graphic bars on the left. Any time at the instantaneous values menu (except THD V% and THD I%), you can scroll between THD V and THD I with pressing ESC button. Harmonic menu can be used for watching the harmonic values detailed.

**Freq. Hz** Frequency of the system.  
 (The frequency is measured from the L1 phase.)

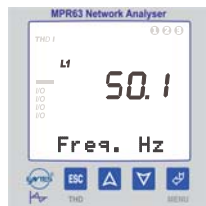

**Average V** The average value of the measured phase-neutral voltages

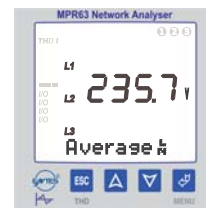

**Average V** The average value of the measured phase-phase voltages

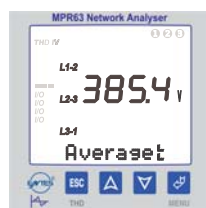

**$\Sigma$ Current** The total current value of all phases

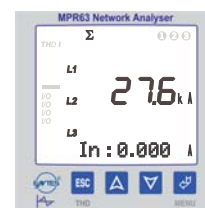
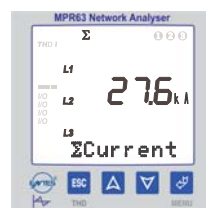

## Watching the Values of the Other Parameters

Other parameters are grouped under the; **ENERGY, HARMONIC, DEMAND, TIME, DATE** menus.

### 4.10 ENERGY

#### The Energy Values:

In this menu, below energy values are displayed and cleared.

**Exp.** Export Active Energy    **Imp.** Import Active Energy

**Ind.** Inductive Reactive Energy    **Cap.** Capacitive Reactive Energy values

These energy values can be cleared one by one or all at once.

#### Imp. (Import Active Energy)

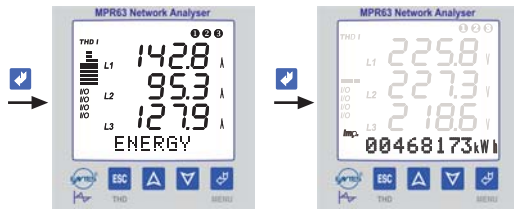

Figure 36: Import Active Energy value

#### Clearing the Import Active Energy value

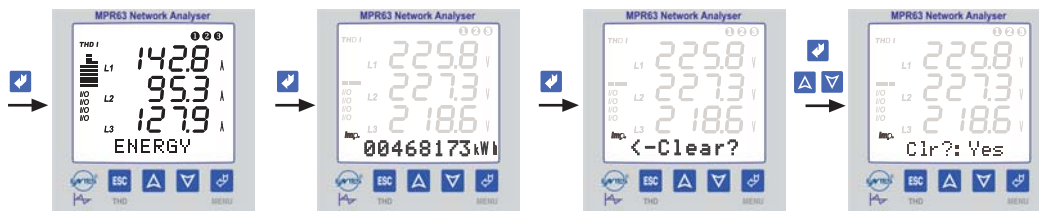

Figure 37: Clearing the Import Active Energy value

#### Exp. (Export Active Energy value)

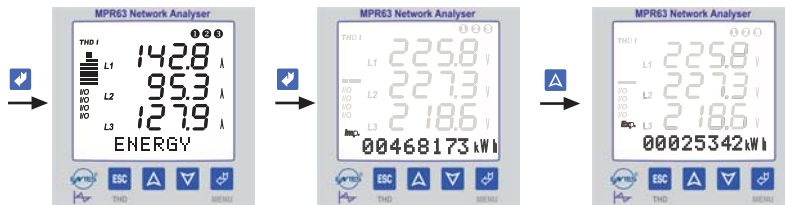

Figure 38: Export Active Energy value

#### Clearing the Export Active Energy value

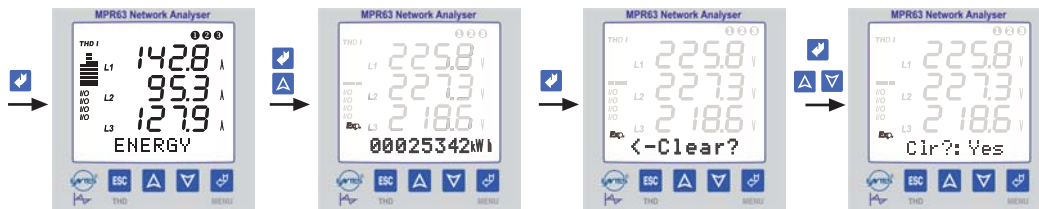

Figure 39: Clearing the Export Active Energy value

#### Ind. (Inductive Reactive Energy)

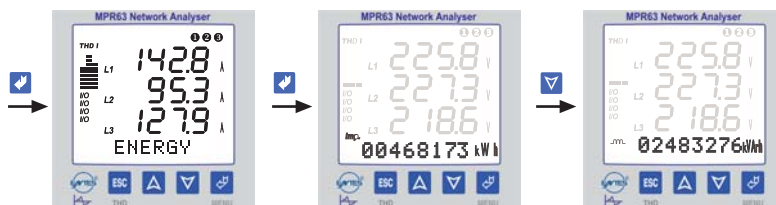



Figure 40: Inductive Reactive Energy value



**Warning :**

You may quit all settings **any time** by **ESC** key.  
You must record any change in the settings by  menu key.

**Clearing the Inductive Reactive Energy value**

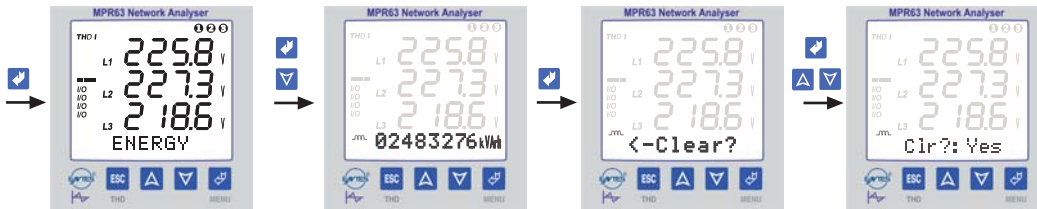

Figure 41: Clearing the Inductive Reactive Energy value

**Cap. (Capacitive Reactive Energy)**

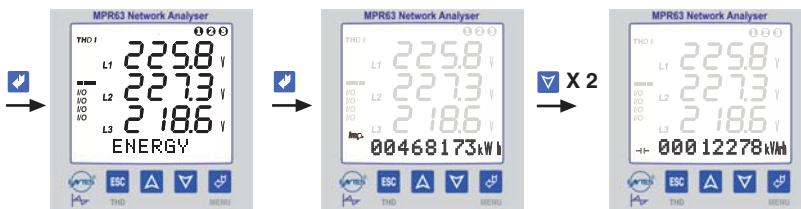

Figure 42: Capacitive Reactive Energy value.

**Clearing the Capacitive Reactive Energy value**

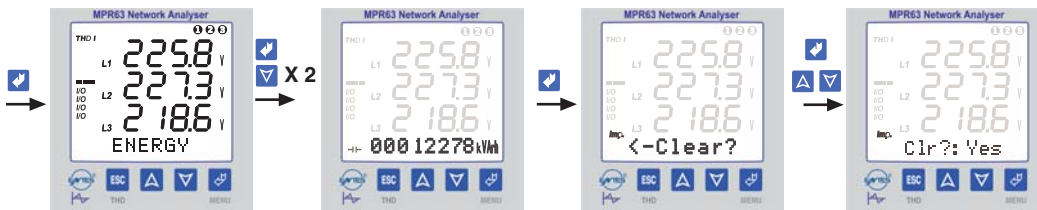

Figure 43: Clearing the Capacitive Reactive Energy value

**Clearing all energy values (Exp, Imp, Ind, Cap)**

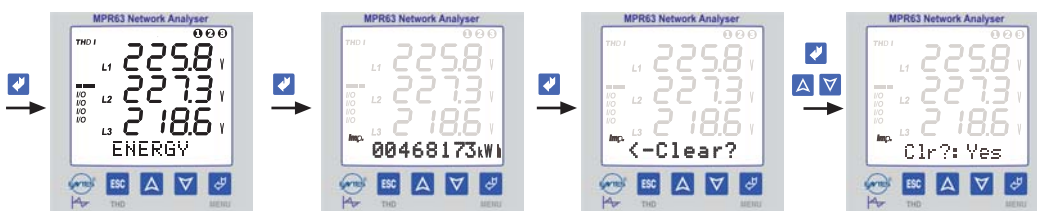

Figure 44: Clearing all energy values

**4.11 HARMONIC**

**Observing the Harmonic Values:**

In this menu, you can observe below parameters :

THD	V%	2nd.....31th..Harmonic Values (One by one for voltage)
THD	I%	2nd.....31th..Harmonic Values (One by one for current )
ΣTHD	V%	Total Harmonic Values (for voltage)
ΣTHD	I%	Total Harmonic Values (for current)



**Warning :**

You may quit all settings **any time** by **ESC** key.  
You must record any change in the settings by  menu key.

**Observing Harmonic Values**

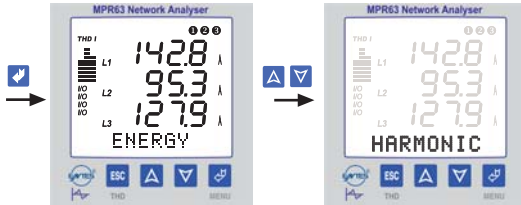

Figure 45: Harmonic values.

**THD V% (Voltage Harmonics)**

The total harmonic values for voltages of each phase and the values of the harmonics between 2nd and 31th of each phase can be seen separately.

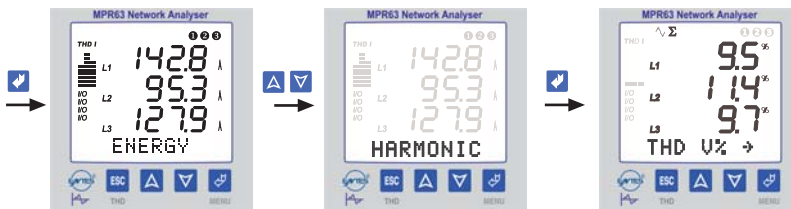

Figure 46: Harmonic values of voltages.

**THD I%: (Current Harmonics)**

It is possible to see both, the total harmonic values for currents of each phase and up to 31th harmonic values of each phase separately.

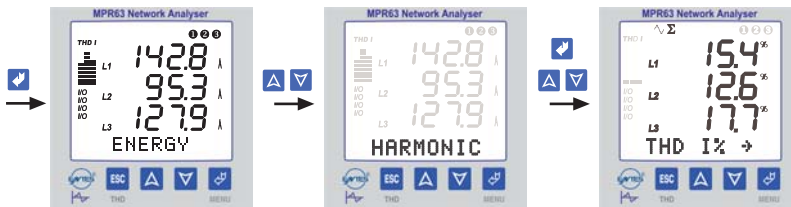

Figure 47: Harmonic values for currents.

**Observing harmonics values for currents from 2nd to 31th harmonics**

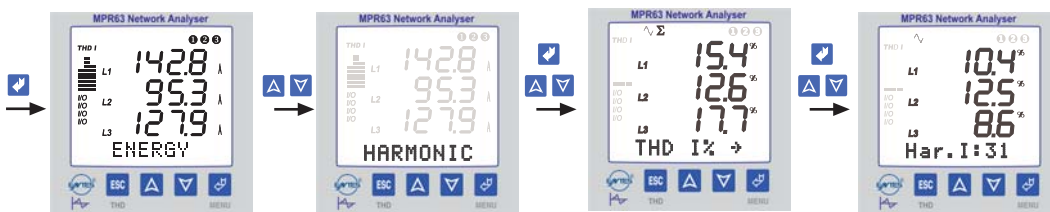

Figure 48: Harmonic values for currents.

**ΣTHD V% (Total Voltage Harmonics)**

In this menu, the total harmonic values for voltages of all phases can be seen.

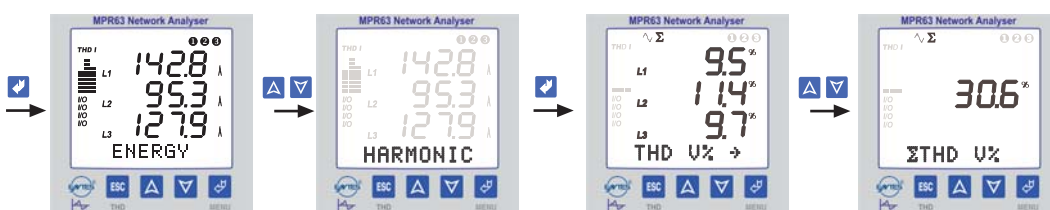



Figure 49: Total voltage harmonics.



**Warning :**

You may quit all settings **any time** by **ESC** key.  
You must record any change in the settings by  menu key.

### ΣTHD I% (Total Current Harmonics)

In this menu, the total harmonic values for currents of all phases can be seen.

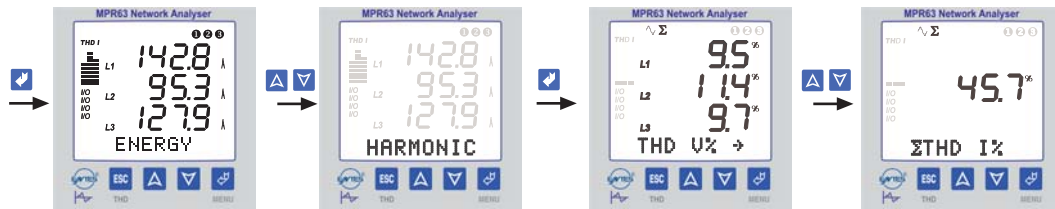

Figure 50: Total current harmonics

## 4.12 DEMAND

### Observing Demand, min. and max. Values

**Demand :** It is the maximum value of average power and current values during demand time (15 minutes)

**Min. value :** It is the minimum value (except 0 “zero”) of the measured voltage and current values.

**Max value :** It is the maximum value of the measured voltage and current values.  
it is also possible to observe the below values;

- \* **max.VL-N** (max. voltage values between Phase-Neutral)
- \* **min.VL-N** (min. voltage values between Phase-Neutral)
- \* **max. IL** (max. Phase current values)
- \* **min. IL** (min. Phase current values)
- \* **Demand IL** (Demand values for phase currents)
- \* **Demand ΣP, Demand ΣQ, Demand ΣS**, (Demand values for total power values)

Minimum, maximum and demand values can be cleared one by one or all at once.

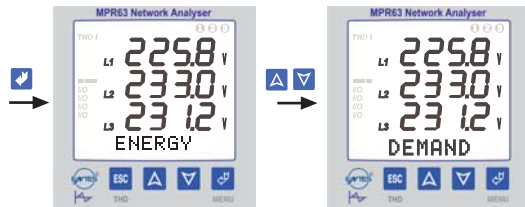

Figure 51: Demand values

### max. VLN (Max. values of the phase-neutral voltages)

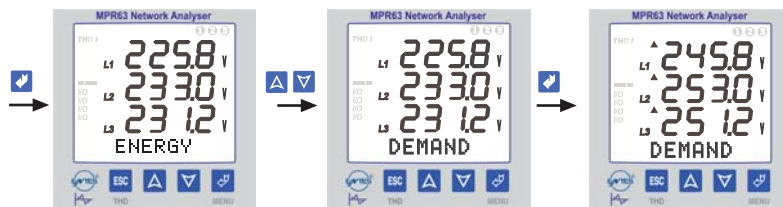

Figure 52: Max. VLN

### Clearing the max. VLN (Max. values of the phase-neutral voltages)

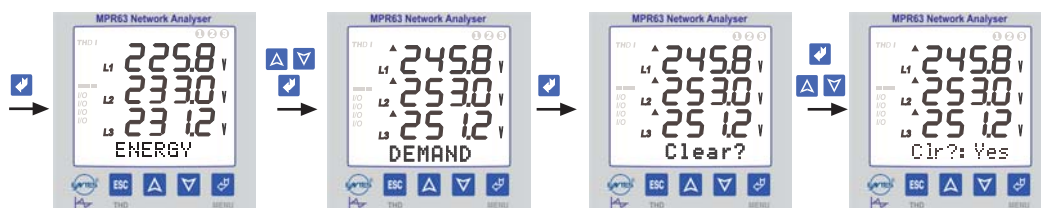



Figure 53: Clearing the max. VLN



**Warning :**

You may quit all settings **any time** by **ESC** key.  
You must record any change in the settings by  menu key.

**Observing the min. VLN (Min. values of the phase-neutral voltages)**

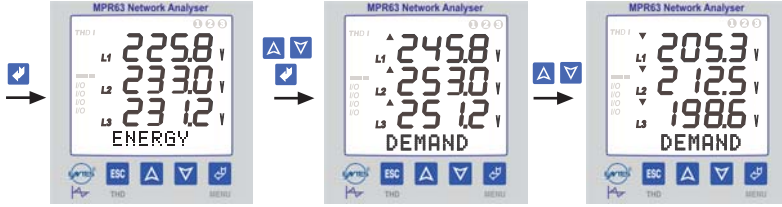

Figure 54: Min. VLN value

**Clearing the min. VLN (Min. values of the phase-neutral voltages)**

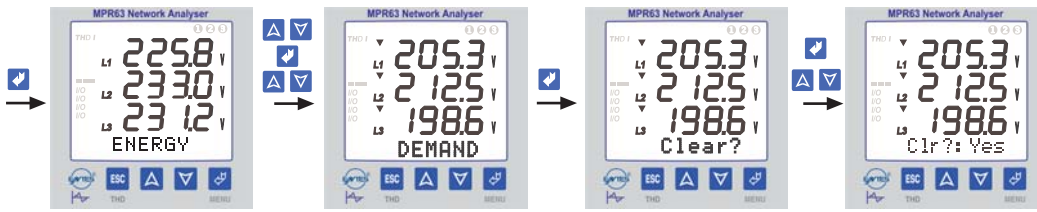

Figure 55: Clearing the min. VLN value

**max. IL (Max values of phase currents)**

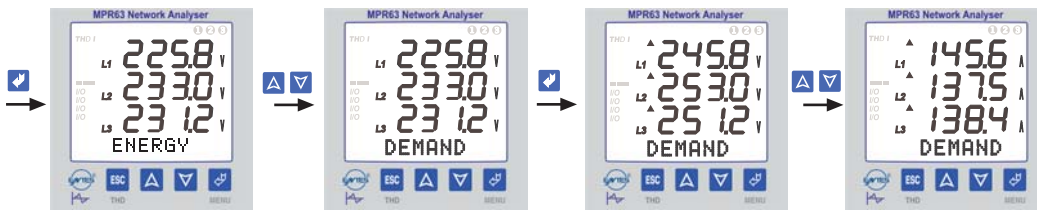

Figure 56: Max. IL value

**Clearing the max. IL (Max values of phase currents)**

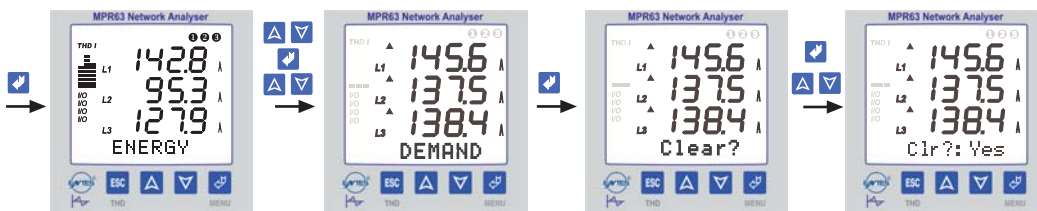

Figure 57: Clearing the max. IL value

**min. IL (Min values of phase currents)**

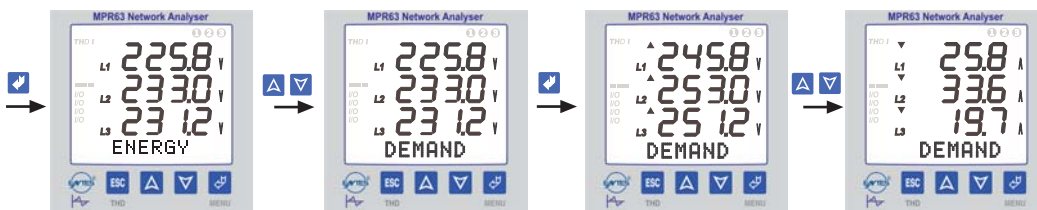

Figure 58: Min. IL value

**Clearing the min. IL (Min values of phase currents)**

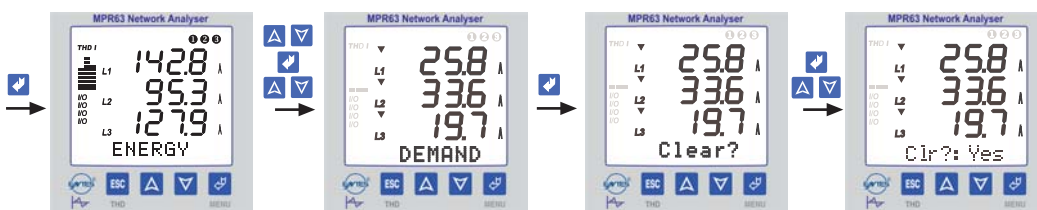



Figure 59: Clearing the min. IL value





**Warning :**

You may quit all settings **any time** by **ESC** key.  
You must record any change in the settings by  menu key.

**Demand IL (Demand values of the currents)**

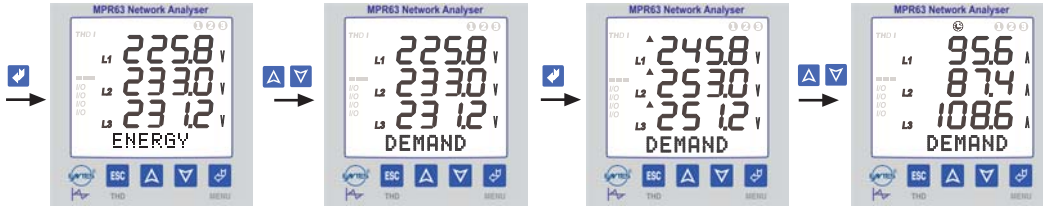

Figure 60: Demand IL

**Clearing the Demand IL (Demand values of the currents)**

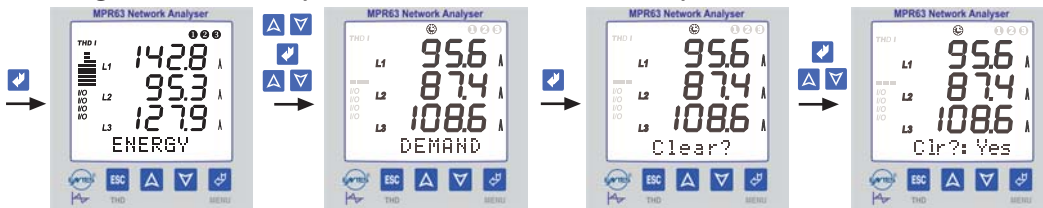

Figure 61: Clearing the demand IL

**Min. / Max.  $\Sigma I$  (Min and max values of total phase currents)**

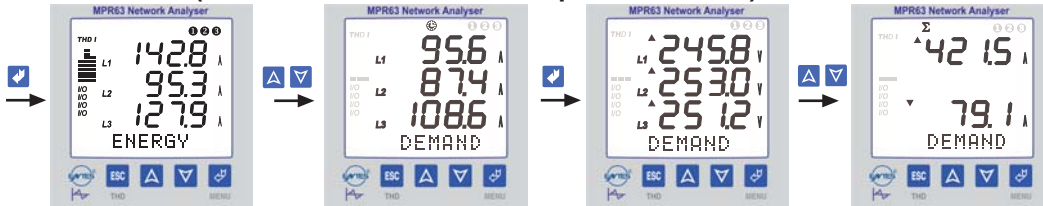

Figure 62: Min. / Max.  $\Sigma I$

**Clearing the Min. / Max.  $\Sigma I$  (Min and max values of total phase currents)**

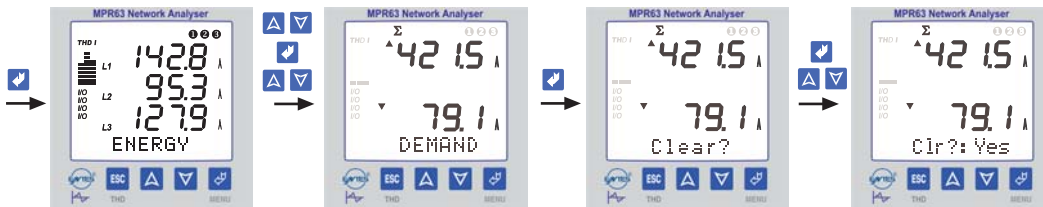

Figure 63: Clearing the Min. / Max.  $\Sigma I$

**Demand  $\Sigma$  Powers (Demand values of total powers)**

Active (P), Reactive (Q) and Apparent (S) Powers

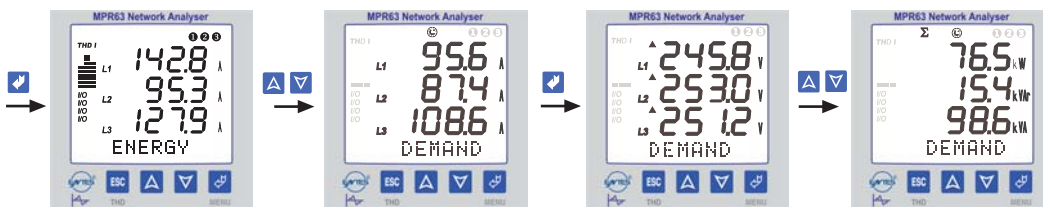

Figure 64: Demand  $\Sigma$  Powers

**Clearing the Demand  $\Sigma$  Powers (Demand values of total powers)**

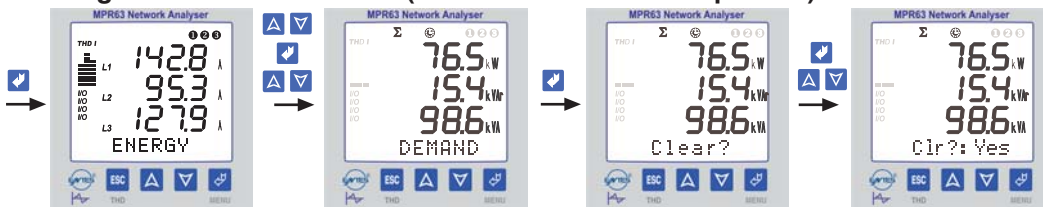

Figure 65: Clearing the Demand  $\Sigma$  Powers

## Clearing All Demand values and Min. / Max. Values at Once

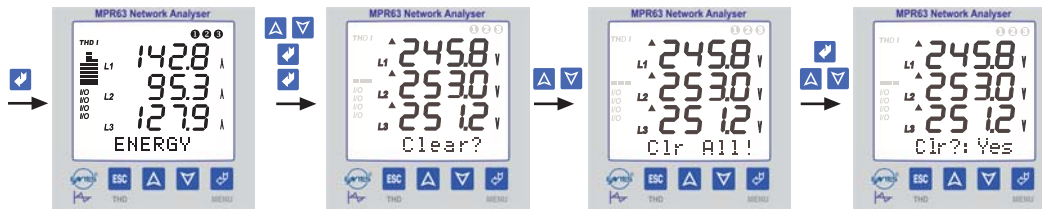

Figure 66: Clearing all demand values and min. / max. values at once

## 4.13 TIME AND DATE

### Time and Date Menus

Time and Date, which are configured from the SETUP menu, are kept in the memory.

Even if the power is switched off, the informations of time and date are saved into the memory.

### TIME (Menu for observing the time)

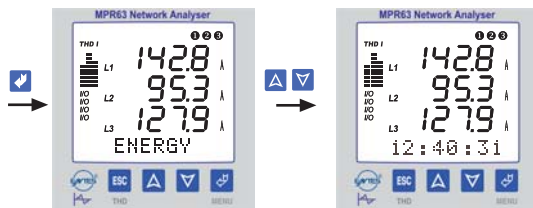

Figure 67: Time

### Date (Menu for observing the date)

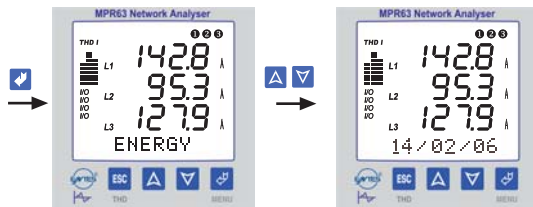

Figure 68: Date

## 4.14 INFO

### INFO

The information about the memory of the device and the manufacturer are seen in this menu.

Information menu has three sub-menus.

**Log.Rec..... Eng. Rec.....Producer-Production Information.....**

#### Log. Rec.:

This menu gives us information about the quantity of record lines of the parameters from Pr1 to Pr28 at the top line and indicates the occupied memory.

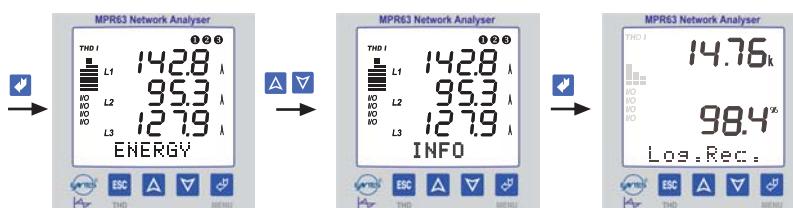

Figure 69: Info

Above, 14760 record lines are memorised and 98,4% of the memory is used.

**See page 19 for Datalog Menu**

### Clearing all recorded parameters from Pr1 to Pr28 in Log. Rec. permanent memory

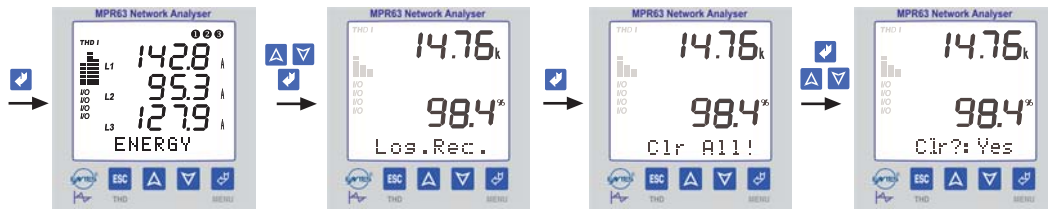

Figure 70: Clearing all recorded parameters

### Eng. Rec. (Energy recording)

MPR63-41 records all energy values ( Export Active, Import Active, Inductive Reactive, Capacitive Reactive) in the permanent memory for energy values in every 15 minutes. 1.000 record lines are allocated for energy values. When this area is filled, all energy recordings are cleared to enable further records.



**Note:** Allocated areas for parameter and energy values are independent from each others. The permanent memory is not affected from power cuts.

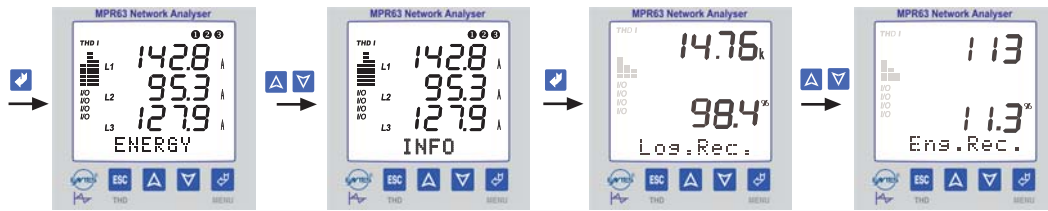

Figure 71: Energy records

Above, 113 record lines are memorised and 11,3% of the memory is used.

### Clearing all recorded parameters from Pr1 to Pr28 in the Eng. Rec. permanent memory

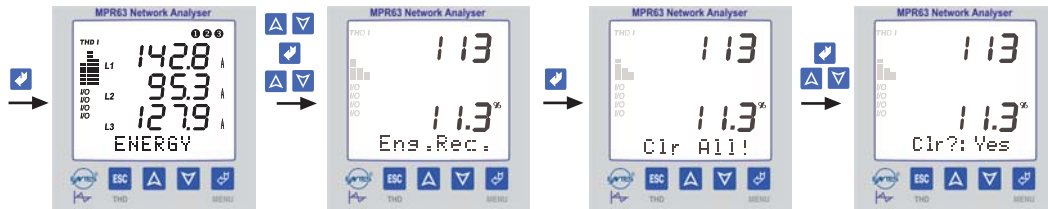

Figure 72: Clearing all recorded parameters in the Eng. Rec. permanent memory



**Note :** If data records, which are saved in to the permanent memory for every 15 minutes in Eng.Rec. Menu, are cleared, energy values are not affected from this event.

### 4.15 Manufacturer - Product Information

Information about manufacturer, the version number of the device, company contact information and serial number (8 digit) are on this menu.

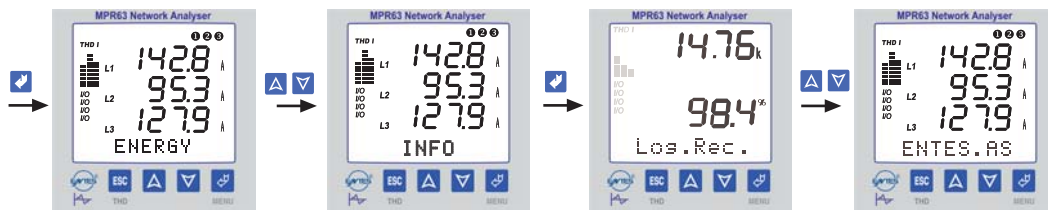

Figure 73: Manufacturer - Product Information

## 4.16 PASSWORD

User password is set and activated in this menu.

In order to prevent the device's SETUP, DEMAND and ENERGY menus from unauthorized access, it is necessary to set up a 3 digit user password and then activate it.

### Set Psw (Menu for setting up a user password)

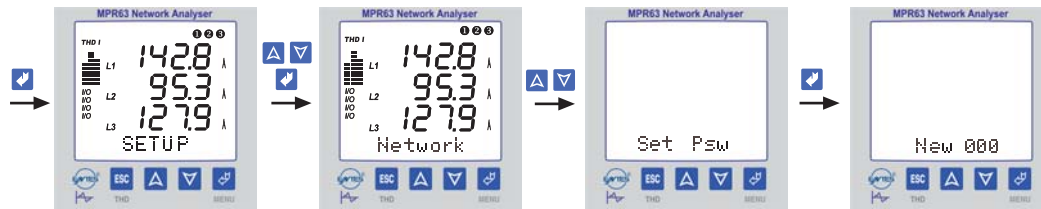

Figure 74: Setting the password

### Chg Psw (Menu for changing the user password)

The new password is saved to the SETUP, DEMAND and ENERGY menus.



Figure 75: Changing the password

Main Password : 236

## 4.17 PARAMETER TABLE

The parameters, that can be set, are marked with an \* symbol in the parameter table.

*V <sub>L1, L2, L3</sub>	(Phase Voltages)
*V <sub>L12, L23, L31</sub>	(Phase-Phase voltages)
*V. <sub>̄</sub> (Average)	(Total Phase Voltages Average)
*V. <sub>̄</sub> (Average)	(Total Phase-Phase Voltages Average)
*Freq.Hz	(Frequency)
*I <sub>L1, L2, L3</sub>	(Phase Currents)
*I <sub>n</sub>	(Neutral Current)
*ΣI	(Total Phase Currents)
*P <sub>L1, L2, L3(W)</sub>	(Active Power)
*Q <sub>L1, L2, L3(VAr)</sub>	(Reactive Power)
*S <sub>L1, L2, L3(VA)</sub>	(Apparent Power)
*ΣP. (ΣW)	(Total Active Power)
*ΣQ. (ΣVAr)	(Total Reactive Power)
*ΣS. (ΣVA)	(Total Apparent Power)
*COS <sub>φL1, L2, L3</sub>	(Displacement Power Factor)
*PF <sub>L1, L2, L3</sub>	(Power Factor)
ΣP. F	(Total Power Factor)
Exp.(KWh)	(Export Active Energy)
Imp.(KWh)	(Import Active Energy)
Ind. (KVArh)	(Inductive Reactive Energy)
Cap.(KVArh)	(Capacitive Reactive Energy)
*H-V <sub>L1, L2, L3</sub>	(Harmonic Values for Voltages)
THD V% 2.-31.	(Total Harmonic Values for Voltages)
*H-I <sub>L1, L2, L3</sub>	(Harmonic Values for Currents)
THD I% 2.-31.	(Total Harmonic Values for Currents)
Demand max.VLN	(Maximum Phase Voltages)
Demand min. VLN	(Minimum Phase Voltages)
Demand max. IL	(Maximum Phase Currents)
Demand min. IL	(Minimum Phase Currents)
Demand IL	(Demand Phase Currents )
Demand ΣIL	(Total Demand Phase Currents)
Demand ΣW	(Total Demand Active Powers)
Demand ΣVAr	(Total Demand Reactive Powers)

## 4.18 FORMULAS

RMS Values for Voltages	$V_{rms} = \sqrt{\frac{1}{N} \sum_{i=0}^N V_i^2}$	RMS Values for Currents	$I_{rms} = \sqrt{\frac{1}{N} \sum_{i=0}^N i_i^2}$
Total Active Power	$P = \frac{1}{N} \sum_{i=0}^N p_i$	Total Reactive Power	$Q = \frac{1}{N} \sum_{i=0}^N q_i$
Apparent Power	$\Sigma S = \sqrt{\Sigma P^2 + \Sigma Q^2}$	Total Power Factor	$\Sigma P.F = \frac{\Sigma P}{\Sigma S}$
Total Harmonic Distortion for Voltages	$V_{THD} \% = \frac{\sqrt{\sum_{i=2}^{31} V_i^2}}{V_1} \times 100$		$\Sigma V_{THD} = V_{THD1} + V_{THD2} + V_{THD3}$
Total Harmonic Distortion for Currents	$I_{THD} \% = \frac{\sqrt{\sum_{i=2}^{31} I_i^2}}{I_1} \times 100$		$\Sigma I_{THD} = I_{THD1} + I_{THD2} + I_{THD3}$

## 4.19 ANALOG OUTPUT (0/4-20mA)

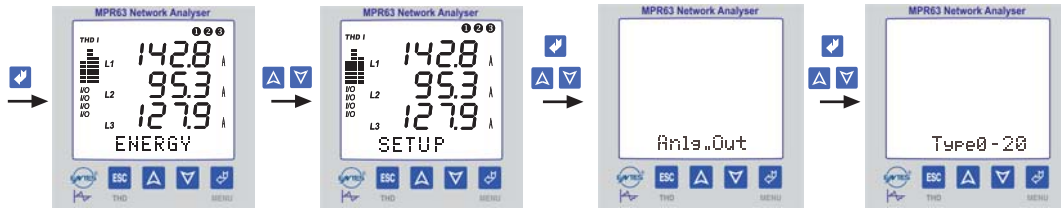

In MPR63-41, this feature gives the possibility that observing the measured values by other devices with converting these values in to 0-20 mA or 4-20 mA current data.

The below parameters can be set as Analog output in MPR63-41.

VL1, L2, L3	(Phase Voltage)	$\Sigma I$ . ( $\Sigma A$ )	(Total Phase Currents)
VL12, L23, L31	(Phase-Phase Voltage)	$\Sigma P$ . ( $\Sigma W$ )	(Total Active Power)
Frequency	(Frequency)	$\Sigma Q$ . ( $\Sigma VAR$ )	(Total Reactive Power)
IL12, L23, L31	(Phase Currents)	$\Sigma S$ . ( $\Sigma VA$ )	(Total Apparent Power)
PL1, L2, L3 (W)	(Aktif Power)	THD %VL1, L2, L3	(Total Harmonic Values for Voltages)
QL1, L2, L3 (VAR)	(Reactive Power)	THD %I L1, L2, L3	(Total Harmonic Values for Currents)
SL1, L2, L3 (VA)	(Apparent Power)		

### For example ;

Below settings should be fulfilled as like :

Type : 0-20mA  
 Prm (Parameter) : VL1  
 Lo (Low value) : 0V  
 Hi (High value) : 300V

After above settings completed;

Analog output's value will be 0 mA when VL1 value is 0V,  
 Analog output's value will be 20 mA when VL1 value is 300V.  
 When VL1 is 220V Analog output value will be;

$$I_{out} = \frac{(20-0) \times 220}{(300-0)} = 14,67 \text{mA}$$

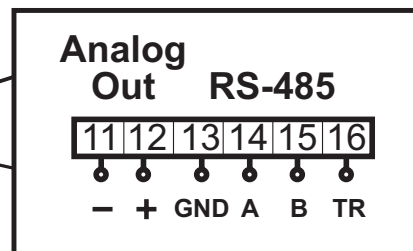
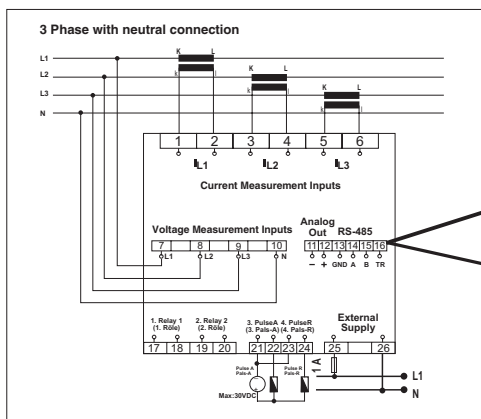
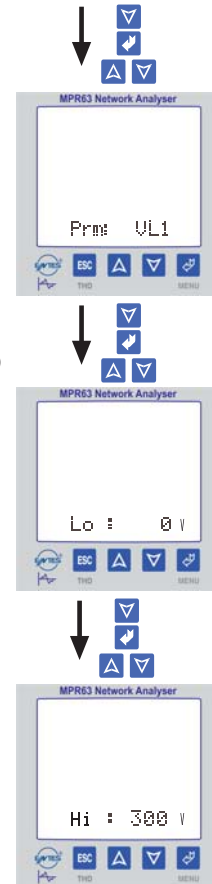

## 4.19 FACTORY SETTINGS

### Network

CT (Current transformer) : 10  
 VT ( Voltage transformer) : 1.0  
 Net (System Connection) : 3P4W  
 Eng (Energy) : Tot.

### Display

Loop (Loop duration) : No  
 Cont (Contrast) : 6  
 BL. (Backlight) : Auto

### RS-485

Addr (Address) : 1  
 Bd (Baud rate value) : 9600 bps  
 Prt (Parity) : None

### Datalog

Per (Period) : 900 sec.  
 Event : No  
 Pr1(Parameter 1) : VL1  
 Pr2(Parameter 2) : VL2  
 Pr3(Parameter 3) : VL3  
 Pr4(Parameter 4) : IL1  
 Pr5(Parameter 5) : IL2  
 Pr6(Parameter 6) : IL3  
 Pr7(Parameter 7) : Σ  
 Pr8(Parameter 8) : P1  
 Pr9(Parameter 9) : P2  
 Pr10(Parameter 10) : P3  
 Pr11(Parameter 11) : Q1  
 Pr12(Parameter 12) : Q2  
 Pr13(Parameter 13) : Q3  
 Pr14(Parameter 14) : S1  
 Pr15(Parameter 15) : S2  
 Pr16(Parameter 16) : S3  
 Pr17(Parameter 17) : PF1  
 Pr18(Parameter 18) : PF2  
 Pr19(Parameter 19) : PF3  
 Pr20(Parameter 20) : Cos1  
 Pr21(Parameter 21) : Cos2  
 Pr22(Parameter 22) : Cos3  
 Pr23(Parameter 23) : V12  
 Pr24(Parameter 24) : V23  
 Pr25(Parameter 25) : V31  
 Pr26(Parameter 26) :  $V_{LN}$   
 Pr27(Parameter 27) :  $V_{LL}$   
 Pr28 (Parameter 28) : Freq.

### 1.Relay1

Cfg : Digital Output  
 Pr1,Pr2,Pr3 (Parameters) : Off  
 Hi1,Hi2,Hi3 (High) : ----  
 Lo1,Lo2,Lo3 (Low) : ----  
 Hs1,Hs2,Hs3 (Hysterisis) : ----  
 Dly1,Dly2,Dly3 (Delay) : ----

### 2.Relay 2

Cfg : Digital Output  
 Pr1,Pr2,Pr3 (Parameters) : Off  
 Hi1,Hi2,Hi3 (High) : ----  
 Lo1,Lo2,Lo3 (Low) : ----  
 Hs1,Hs2,Hs3 (Hysterisis) : ----  
 Dly1,Dly2,Dly3 (Delay) : ----

### 3. Pulse A

Prm(Energy value to set for 1 pulse) : 1 kWh  
 Dur ( Pulse width) : 250 msec.

### 4. Pulse R

Prm(Energy value to set for 1 pulse) : 1 kVArh  
 Dur (Pulse width) : 250 msec.

### Password

Set Psw (Setting up the password) : None (000)

### Analog Output

Type : 0-20mA  
 Prm (Parameter) : None  
 Lo (Low) : -  
 Hi (High) : -

## 4.20 TECHNICAL DATA

Operating Voltage (Un)	: Please look behind the device.
Frequency	: 50 / 60 Hz
Power Consumption	: < 6 VA
Burden	: < 1 VA (Current burden) < 0,5 VA (Voltage burden)
Measurement Input	
Voltage	: 1,0 - 300,0 V AC (L-N) : 2,0 - 500,0 V AC (L-L)
Current	: 5 mA - 5.5 A
Measurement Ranges	
Voltage	: 1,0 V - 400,0 kV
Current	: 5 mA - 10.000 A
Frequency	: 45,0 - 65,0 Hz
Power	: 0 - 4000 M (W, VAr, VA)
Energy	: 0 - 99 999 999 kWh, kVArh
Measurement Category	: CAT III
Accuracy	
Voltage, Current	: 0.5%±2digit
Active Power	: 1%±2digit
Reactive, Apparent Power	: 2%±2digit
Voltage Transformer Ratio	: 1,0...4000,0
Current Transformer Ratio	: 1...2000
Connection Type	: 3P-4W, 3P-3W, ARON
Relay Outputs	: 2 NO, 5A, 1250 VA
Demand Time	: 15 min.
Communication Interface	: MODBUS RTU (RS-485)
Baud Rate	: 1.200 - 38.400 bps
Address	: 1 - 247
Parity	: None, Even, Odd Parity
Data Logging	
Parameters	: Chosen 28 parameters with date and time
Record Size	: 15000 record lines
Log Duration (time interval between 2 records)	: No, 5 - 30.000 seconds
Energy Record	: 1000 record lines (1 record in every 15 minutes)
Event	: Yes, No
Memory	: 1 MB Internal Memory
Energy Pulse Outputs	
Active Energy Pulse Output	: (1 kWh...50 MWh / pulse) - NPN Transistor
Reactive Energy Pulse Output	: (1 kWh...50 MVarh / pulse) - NPN Transistor
Switch Period	: Min. 1sec. (100 msec. - 2500 msec pulse width)
Operation Current	: Max. 50 mA
Operation Voltage	: 5...24 V DC, max. 30 V DC
Analog Output	: 0/20 mA or 4/20mA
Load Resistance	: ≤500 Ω
Response Perriod	: 1 sec.
Real Time Clock	: hh : mm : ss ; dd / mm / yy
Ambient Temperature	: -5°C ; +55°C
Display	: 3,6" LCD with Backlight
Dimensions	: PR19
Equipment Protection Class	: Double Insulation-Class II (□)
Box Protection Class	: IP 40
Terminal Block Protection Class	: IP 00
Box Material	: Non-flammable
Installation	: Flush mounting with rear terminals
Wire Thickness for Voltage Connection	: 2,5 mm <sup>2</sup>
Wire Thickness for Current Connection	: 4,0 mm <sup>2</sup>
Wire Thickness for Pulse Connection	: 1,5 mm <sup>2</sup> (max.)
RS-485 Connection	: Category 5 Cable (Shielded Twisted Pair)
Weight	: 0.75 kg
Installation Category	: Class II
Type	: PR 19
Package Dimensions	: 350x290x240 mm
Package Weight	: 6 kg
Pcs per Package	: 8 pcs